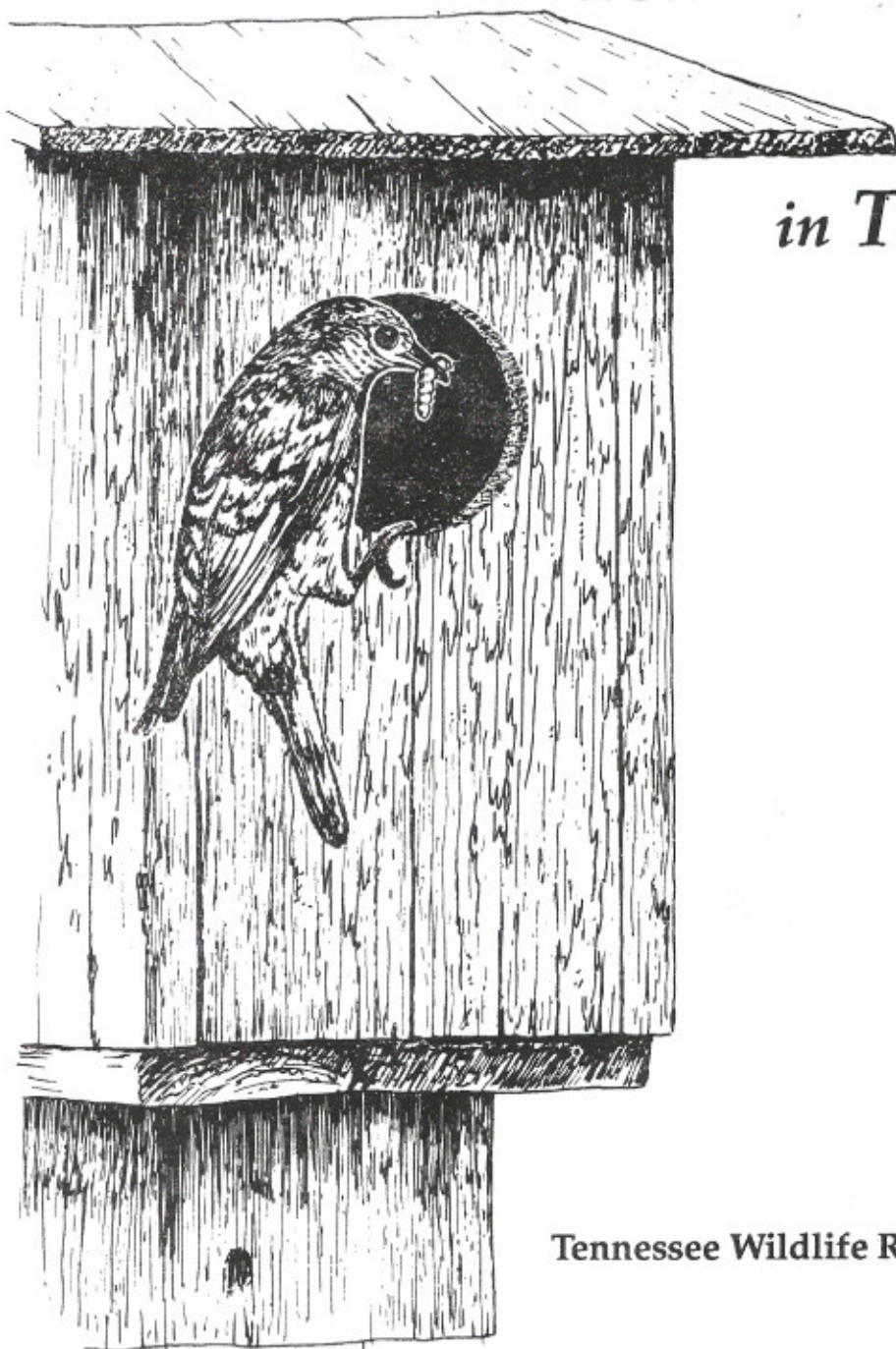


# WOODWORKING for WILDLIFE

*in TENNESSEE*



Tennessee Wildlife Resources Agency



Department of Tennessee Wildlife Resources, Authorization No. 328326, 20,000 copies, February, 1993. This public document was promulgated at a cost of \$.45 per copy.

## WOODWORKING FOR WILDLIFE IN TENNESSEE

Adapted primarily from the Minnesota Woodworking for Wildlife for Tennessee conditions by Robert M. Hatcher, Nongame Coordinator, TENNESSEE WILDLIFE RESOURCES AGENCY, by permission of the Minnesota author, Carrol L. Henderson, Nongame Wildlife Supervisor, Minnesota Department of Natural Resources

### *ART CREDITS*

Wildlife art by Dan Metz and Dan Robinson

House and Platform drawings by Carrol L. Henderson, Judy Voigt-Englund and Mary Miller

The Tennessee Wildlife Resources Agency appreciates the availability of the basic text and majority of drawings for adaptation in this publication.

This publication is partially funded by the Forest Stewardship Program and the Monsanto Company

### *DISCLAIMER*

The use of trade names or references to specific companies or products in this publication does not imply endorsement by the Tennessee Wildlife Resources Agency. They are included only as an aid to the reader.

---

# TABLE OF CONTENTS

Introduction .....	1
General House and Platform Instructions .....	2
<b>Part 1- Nest Boxes and Platforms for Use In Backyards, Farmsteads and and Small Deciduous Woodlots</b>	
House Wren .....	3
White-breasted Nuthatch .....	4
Mourning Dove .....	4
Carolina Chickadee .....	4
Eastern Bluebird .....	5
American Robin .....	6
Barn Swallow .....	6
Eastern Phoebe .....	6
Purple Martin .....	7
Northern Flicker .....	8
Barn Owl .....	8
Bats .....	9
Gray and Fox Squirrels .....	10
Raccoon .....	10
American Kestrel .....	11
<b>Part 2- Nest Boxes and Platforms for Use in Extensive Deciduous or Coniferous Forests</b>	
Barred Owl .....	11
Great Crested Flycatcher .....	12
Prothonotary Warbler .....	12
Eastern Screech-owl .....	12
Northern and Southern Flying Squirrels .....	12
Great Horned Owl .....	12
Eastern Red Squirrel .....	12
Pileated Woodpecker .....	13
<b>Part 3- Nest Boxes and Platforms for Use in Lakes, Rivers, Marshes, Ponds and Adjacent Upland Habitats</b>	
Wood Duck .....	14
Double-crested Cormorant .....	15
Great Blue Heron .....	15
Turtle and Duck Loafing Platform .....	16
Osprey .....	16
Canada Goose .....	16
Cliff Swallow .....	17
Mallard .....	18
<b>Woodworking Plans-Figures 1-20 .....</b>	<b>19-38</b>

## INTRODUCTION

Providing houses for cavity-nesting birds is a popular hobby for almost everyone who enjoys wildlife around their homes. Building houses according to proper specifications, placing them in a suitable habitat, and regularly maintaining the houses can benefit both birds and mammals. If they are not built and maintained properly, they can become either "sparrow slums," remain unused, or actually become a death trap to nesting birds and mammals.

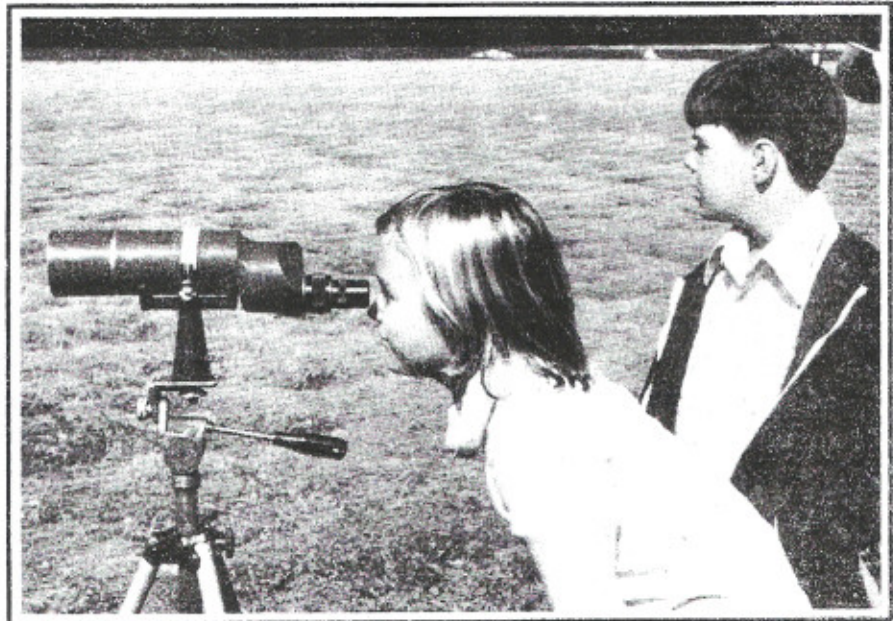
Nest boxes are becoming increasingly important as intensifying forest management and firewood cutting reduce the availability of natural cavities. Nest boxes are therefore helpful for many cavity-nesting species.

Although most people think of eastern bluebirds, purple martins and wood ducks as the primary occupants of houses, many other birds and mammals will occupy them. There are over 30 species of birds in Tennessee which nest in tree holes. So birdhouses are usually built to simulate a natural cavity in a tree. Many other birds or mammals will also adapt to wooden nest platforms if they have the opportunity.

Birdhouses are especially useful in areas that lack large, old, hollow trees for nesting. They can lessen competition by house sparrows and European starlings, because natural cavities have entrance sizes that often admit both of these pest species. Nest boxes for some songbirds, however, can be designed with small entrance holes so that one or both pest species can be excluded.

A variety of game bird and mammal box designs are included in this publication because they are very popular and can be used by many other species as well.

The house and platform instructions have been simplified as much as possible. Most patterns are "one-board" houses, including those in Figures 1, 4, 6, 8, 10, 12 and 14. And right-angle cuts are used wherever feasible.



*Wildlife watching is one of the fastest growing activities in Tennessee.*

This booklet is written in three sections according to the habitats involved. The first includes houses and platforms appropriate for use in backyards, farmsteads, pastures and small woodlots of deciduous trees (hardwoods). The second includes houses and platforms for use in more extensive stands of deciduous or coniferous forest. The third section contains information that can be used near lakes, rivers, marshes and adjacent habitats.

Please remember that placing and maintaining these nest structures does not eliminate the need for preserving and managing wildlife habitat or preserving snags (dead trees) for wildlife. Building, placing and maintaining sites for nests should be considered a technique for enhancing existing habitat and/or adding to personal opportunities to see and enjoy wildlife.

This information is for everyone from children in nature classes to professional wildlife biologists. Included are directions on how to build 19 different structures that will accommodate 33 different species.

There are many creative ways to apply this material. For example, it can be used in high school and middle school industrial arts classes or in workshops of state parks, county parks or retirement homes. These houses can be built and sold as fund-raising projects for youth or civic groups. Sportsmen's clubs and civic groups can build the houses and erect them on the grounds of hospitals and retirement homes.

Try building some as Christmas or birthday gifts. Watching the miracle of life unfold at a robin nesting shelf or wren house can be a thrilling experience for your family and friends.

## GENERAL HOUSE AND PLATFORM INSTRUCTIONS

Birds and mammals need different kinds of houses or platforms in different habitats. These general instructions will help you build and place these structures for the most popular occupants of wildlife homes in Tennessee.

The following general instructions apply to all plans:

1. Do not make a box for "birds." Build it for a specific kind of bird or mammal. Different species have different house-size and entrance-hole requirements.
2. Provide a hinged side or roof so the houses can be easily checked and cleaned out each year. Hinges should be rust-proof. Duck and owl box roofs kept shut with a hook and eye can be opened by raccoons. It is much better to use several paired roofing nails with large heads on the side of the roof and on the upper edge of the side. Wire these paired nails together.
3. At least four 1/4-inch diameter drain holes should be drilled in the bottom of every house, except the Peterson bluebird house. (The sloping floor and space that allows the swing-door front to open, provide for drainage on that particular design.)
4. Although wren houses can be suspended from an anchor point under the eaves or a tree limb, all other houses should be firmly attached to a support post, building or tree. When you attach a nest box to a live tree use lag screws and washers so as years pass, you can gradually unscrew them to allow for the tree's growth. However, do not place bluebird houses on trees because that invites competition from too many other species.
5. Don't put perches on any birdhouses. Only house sparrows and European starlings prefer perches. If you have a house with a perch, take it off. A slab of wood with the bark attached may be placed horizontally under the entrance of a wood duck entrance hole to make it easier for landing at the opening.
6. The top-front edge of a birdhouse should overhang at least 2 inches to help protect the entrance hole from wind-driven rain and to keep cats from reaching in from above.
7. Drill at least two 1/4-inch holes near the top of the right and left sides of all birdhouses—except duck boxes—to provide ventilation. Providing adequate ventilation is very important for small birdhouses.
8. Use galvanized nails to build houses if necessary, but remember: they become loose as the wood expands and contracts in extreme weather conditions. Cedar and redwood nest boxes should probably be made with concrete coated or ring shank nails. They won't allow the boards to loosen.
9. Enclose the floorboard with the sides of a birdhouse—don't nail them to the top of the floorboard. This keeps rain from seeping into the crack between sides and floor and then into the nest. Recess the floorboard 1/4 inch up from the bottom of the sides to help prevent deterioration caused by moisture. This prevents rain from seeping across the bottom of the floor and then up.
10. Do not use tin cans, milk cartons or metal for nests. Metals heat up in direct sun, overheating the eggs and killing the young. However, commercial martin houses made from aluminum are acceptable. Commercial plastic wood duck houses are also acceptable but should be placed in shady locations.
11. Wood is the best all-around material for houses. Three-quarter inch boards are the easiest to work with. Softwood such as pine is fine for smaller nests, but cedar, redwood or cypress may be used for larger boxes. Pine or plywood can be used for duck boxes if they are treated on the outside of the box with wood preservative. Do NOT use wood treated with green preservative. When exposed to water the green copper-based preservative can produce poisonous vapors. A well-constructed house should last 10 to 15 years. Large boxes like duck boxes can be painted with wood preservative on the outside to extend their usefulness. The back should be coated several times because it is most prone to rotting. Do NOT paint, stain or treat a box with creosote.
12. Purple martins and wood ducks do not defend territories around their nests. Therefore, martins should be provided with "apartment type" houses, and duck boxes can be clustered in groups of two or four. Houses for other bird species should be spaced apart to reduce territorial conflicts. Bluebird houses need 100-yard spacing.
13. Small animals may take up residence in birdhouses, including mice, squirrels, bees and wasps. If not acceptable, remove the nests. Otherwise, you will probably need to put up additional houses to accommodate both the unexpected tenants and the desired ones.
14. If wasps take over a house, remove the wasp nest and spray the interior with a disinfectant like Lysol. Use extreme caution to avoid being stung. A can of aerosol insecticide may be necessary during the removal process for "self-defense." If an ant colony becomes established, place a commercial ant killer like Terro in an upside down pop bottle cap under the nest.
15. Blowfly eggs and larvae will sometimes become established in a bluebird nest. The larvae will suck blood from the young birds. If this occurs, lift up the nest with your fingers and tap it gently. The larvae will fall through the nesting material and can be removed from the bottom of the box.
16. Whenever house sparrows or European starlings begin nesting in a birdhouse, tear out the nest and eggs since they are not protected by State or federal law. Nests may need to be removed five or six times before the birds finally abandon the house. Sparrow nests are typically characterized by a messy structure of grass, assorted litter and garbage. Their

eggs are white speckled with brown. Some people prefer to minimize sparrow problems by catching and removing adult sparrows in the nest boxes. Starling nests are an untidy structure of stems and leaves. Their eggs are 30mm long, slightly glossy and pale blue. An efficient cedar house sparrow/starling trap is available from Purple Martin Conservation Association, Edinboro University of Pennsylvania, Edinboro, Pennsylvania 16444 (814/732-2610) at a cost of approximately \$40 (1990 price). Effective wire traps for house sparrows are available for about \$15.

17. When the nesting season is over, open the front or side of a songbird house and leave it that way during the winter to prevent deer mice from nesting. Otherwise these mice may defend "their" box from returning songbirds in the spring by killing

- and eating songbirds which enter.
18. Be sure to allow for the width of the saw blade when marking a board.
19. Remember that the width and depth of lumber purchased at lumber yards is smaller than its standard description. For example, a 1" x 6" board is actually 3/4" x 5 1/2". A 2" x 4" is actually 1 1/2" x 3 1/2". The plans in this booklet utilize the actual dimensions of boards to make the most efficient use of wood.
20. Sawdust may not be the best material for lining a nest box for birds of prey (northern screech-owl, barred owl and American kestrel) or waterfowl (wood duck and hooded merganser). It tends to pack down when wet and to retain moisture. Wood chips from a chainsaw seem to be a better lining. The chips allow for better drainage and less water retention.

21. Any birdhouse entrance hole 1 3/8 inches in diameter or larger will admit house sparrows and any entrance hole larger than 1 1/2 inches in diameter will admit European starlings. Whenever possible, the entrance hole dimensions for songbirds in this booklet are designed to exclude these pest species.
22. The actual sizes of the entrance holes for all songbird, woodpecker and squirrel nest boxes are shown in Figure 20. The actual sizes of entrance holes for all duck and raccoon nest boxes are shown in Figure 21. These holes can be traced onto wood using carbon paper.
23. Mount an inverted metal "cone" high on either wooden or metal nest box poles as a guard against all pole climbing predators.

## PART 1:

Nest boxes and platforms generally for use in backyards, urban areas, farmsteads, orchards, pastures and small deciduous woodlots under five acres

### House Wren

(Figure 1)

The house wren is expanding in Tennessee and is one of our most enjoyable backyard birds. Its beautiful bubbling calls are a joy to hear during the summer.

House wren nest boxes are likely to be used if they are 5 to 10 feet above the ground and located under the eaves of a building or in a tree. This is the only kind of birdhouse that can be free-hanging from an eye-screw. All others need to be firmly anchored. House wren holes are too small for house sparrows or European starlings to use. Don't put a perch on the nest box. Perches invite sparrows to try using the nest. If you have a perch on a wren house, take it off.

The entrance hole for a wren house should be 1 inch in diameter. The 1 1/4-inch hole size shown in Figure 1 also allows use by chickadees and nuthatches,



House Wren

but not house sparrows.

House wrens generally nest in wooded, shrubby habitats. Their nests are characterized by twigs and the six to eight eggs are finely speckled with reddish spots. Sometimes wrens will take

over the nest of an eastern bluebird after puncturing the eggs of the bird with their bills.

As soon as one family of wrens leaves a house, clean it out so another brood of young ones can be raised.

## White-breasted Nuthatch

(Figure 1)

The white-breasted nuthatch is well-known at winter bird feeders as it hangs upside down to eat suet and probe for insect larvae under the bark of trees. It will also nest in mature hardwood forests in a habitat similar to that used by chickadees.

As soon as each brood of young leaves the nest box, clean it out so more birds can use it. Nuthatches need an entrance hole 1 1/4 inches in diameter. This allows use by house wrens and Carolina chickadees, but not house sparrows. Houses should be about 12 to 20 feet above the ground.

## Mourning Dove

(Figure 2)

Mourning doves are one of Tennessee's most abundant and adaptable birds. They do not nest in tree cavities or nest boxes, but they will use a simple, shallow cone of 1/4- or 1/2-inch mesh hardware cloth wired into the horizontal crotches of tree limbs. First, cut out a 12-inch square piece of hardware cloth with tin snips. Trim the square to form a circle 12-inches in diameter. You can also use composition asphalt shingles with the black side up. If you do, cut out a 1-inch diameter circle in the center of the cone to allow for drainage.

Next, cut out a pie-shaped wedge from the circle which is about 2 1/2-inches wide along the outer edge of the circle. Pull the two cut edges together and overlap them about 1 inch. Wire or staple the two edges together.

Place the nest cone in moderate shade in the crotch of a horizontal tree limb 6 to 16 feet above the ground. There should be open space around the nest cone for easy access by the doves. Use roofing nails, staples or wire to fasten the nest securely in place. Bend back the cut edges of the cone so that the sharp points of wire do not stick out.

Dove nests are very simple structures made of twigs. They usually contain two white eggs. Mourning doves usually nest two or three times every

summer. Sometimes selecting an old robin or grackle nest.

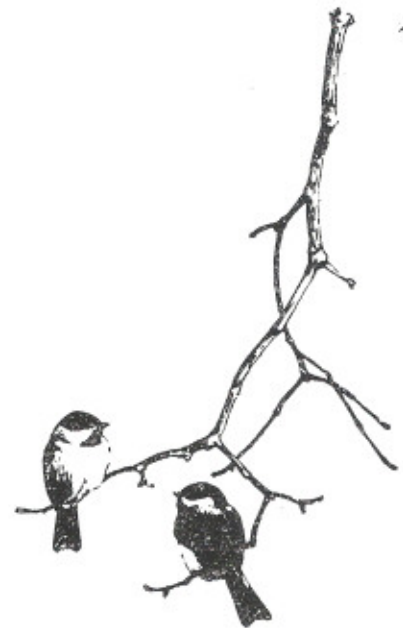
The simple and inexpensive nest cone is an excellent one for young people to make in nature classes.

## Carolina Chickadee

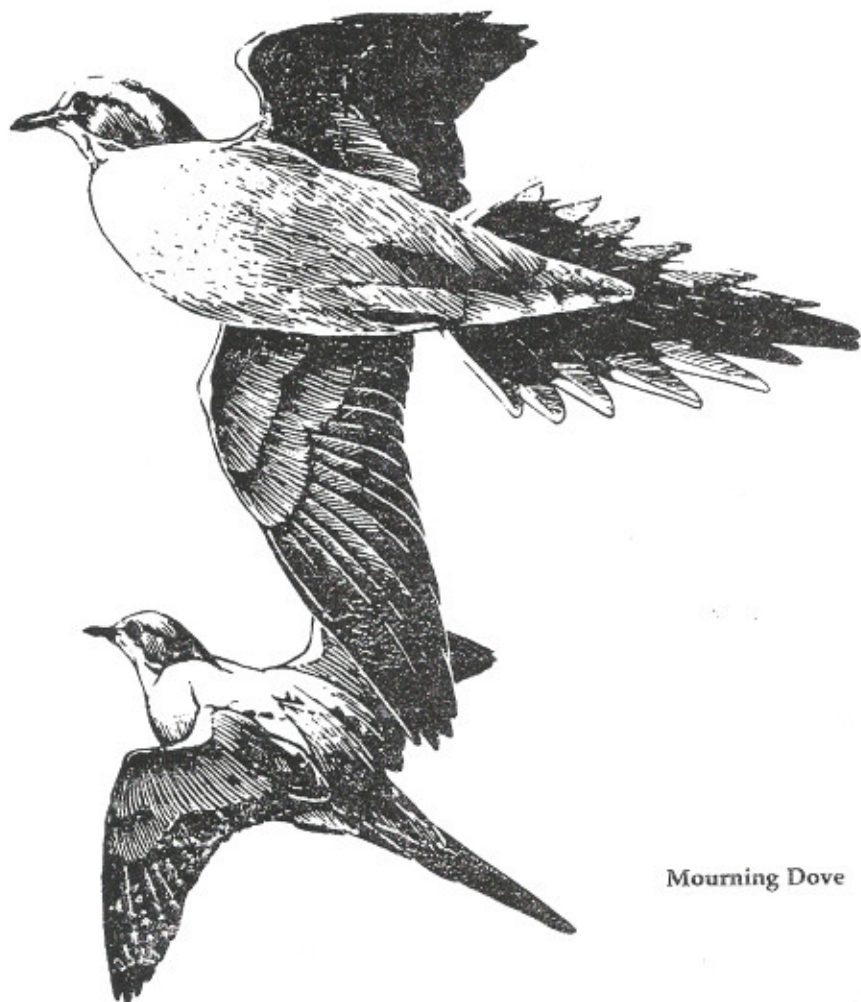
(Figure 1)

Many people enjoy these delightful birds at their feeders every winter but don't realize they will also nest in yards and woodlots with mature hardwood trees.

The house shown will be used by Carolina chickadees if placed in the proper habitat: either mature hardwood or woodlots in agricultural areas and mounted 5- to 15-feet high with 40 to 60 percent sunlight. Place about an inch of wood chips or sawdust in the bottom of the nest box. The chickadee needs an entrance hole 1 1/8 inches in diameter. A hole 1 1/4 inches in diameter as shown in Figure 1 also allows use by wrens and nuthatches, but not house sparrows.



Carolina Chickadee



Mourning Dove

## Eastern Bluebird

(Figures 3, 4, 5)

Eastern bluebirds are one of the most popular songbirds in Tennessee. Their brilliant blue color, delightful calls, clean habits and family devotion have long provided happiness and inspiration to people.

Ideal bluebird habitat is comprised of mixed hardwood forests and grasslands. The grassy areas may be either meadows, pastures, yards, cemeteries, highway rights-of-way or prairies. It is best if the grass is short or sparse. Mowed or grazed areas furnish good settings. There should be either power lines, fence posts, or scattered trees in grassy areas to provide feeding perches. Bluebirds will sometimes nest in the backyards of homes in rural areas or on the fringe of urban areas. However, they normally nest in rural areas away from farmstead sites because competition with house sparrows is usually too great.

Bluebird nests are neat, cup-shaped structures made of fine grass. Usually there are five pale blue eggs in a clutch.

The Peterson bluebird house offers an excellent design. It is relatively safe for the birds and is easily checked and cleaned.

The seven parts of the house are assembled in this order: First, the inner roof is toe-nailed to the top of the back. Second, the floor is toe-nailed to the back 10 1/2-inches below the top. Third, one side is nailed to the resulting frame. Then the other side is nailed to the frame. Next the swing-down front is fastened by nailing one nail to each side of the base. A third nail is pounded part-way into the side near the entrance hole. This is pulled out each time the house is checked. Finally the outer roof is nailed on top. This top serves primarily as a cat guard.

A one-board bluebird house (Figure 4) is much easier to build than the Peterson house and is included here for the benefit of young people or adults who do not have access to table saws or radial arm saws. However, this type of house is more vulnerable to predation by house cats so it is best used on free-standing posts which have tin or aluminum sheets stapled around the support post. Some people feel that sparrow use



Eastern Bluebird

in the one-board house can be diminished by cutting a 3-inch diameter hole in the roof and covering the hole with 1/4- or 1/2-inch hardware cloth mesh. Bluebirds don't seem to mind the "sunroof" but sparrows may be discouraged by it.

Either the Peterson or the one-board bluebird houses should be placed 4- to 6-feet above the ground and spaced about 100-yards apart. The entrance hole should face north, east, or northeast to prevent sunlight from shining directly into the hole and overheating the box interior. A bluebird trail consists of five or more houses placed along a road or fence line. The houses should be ready by late March and should be checked every week to 10 days from late March until late August. A nest should be removed as soon as a brood leaves its nest box. This allows a second brood to be raised.

One additional nest structure for bluebirds is the nesting post shown in Figure 5. It consists of a 9-inch deep cavity drilled into 6-inch diameter fence posts. The hole in the post top is 3 5/8 inches in diameter. A Milwaukee drill

bit and extension shaft are used on a heavy duty Milwaukee drill to make the cavity. Electricity in the field is provided by a gasoline-powered generator and extension cord, or posts can be drilled in a shop before installation. This type of house is especially desirable in county parks, wildlife management areas, and roadside rights-of-way where traditional box type houses are sometimes vandalized. The nesting posts are very inconspicuous. They can be free standing with predator guards or they can be a part of functional sign posts or fence lines. The posts may be treated or untreated cedar.

Nesting posts are constructed in five steps. First, an entrance hole 1 3/8-inches wide and 2 1/4-inches high is drilled. This is done by drilling two overlapping holes with a 1 3/8-inch bit, or drill a single round hole 1 1/2" in diameter. Second, the main cavity is drilled to a depth of 9 inches. Don't straddle the barbed-wire fence when drilling this hole. Third, four 1/4 inch diameter holes are drilled into the base of the cavity from the outside to allow for water drainage. Fifth, an 8" x 8"

piece of plywood or treated pine board is screwed onto the top of the post. Hardware cloth can be used to cover the top of the post if sparrow use is a problem. The open top may discourage the sparrows. The nests are checked by removing the top. Old nests are easily removed from above.

See Item 16 of the "General Instructions" section concerning effective sparrow/starling traps.

## American Robin

(Figure 6)

One of the most enjoyable backyard bird species is the American robin. Its song is beautiful, and it provides great enjoyment for people as it raises its young each summer. Its grassy nest is lined inside with mud, and the eggs are bright blue.

A robin nesting shelf can be placed on a wall by a window where the robin family can be easily seen. Or the nesting shelf can be placed on the trunk of a tree about 6 to 10 feet above the ground. The nesting shelf can be left unpainted, or painted an earth tone. The asphalt composition shingle nesting cone described for mourning doves will also be used by robins.

Remove the robin's nest after the young leave as robins build a new nest each year.

## Barn Swallow

(Figure 6)

Barn swallows are a common inhabitant of farmsteads where they frequently nest on the rafters of barns and other outbuildings. Their mud nests are usually stuck onto the sides of rough-sawn rafters. These beautiful birds eat flying insects and are characterized by iridescent bluish-black backs, reddish breasts and deeply forked tails.

Barn swallows will also use the nesting shelf illustrated in Figure 6. Sometimes barn swallows are a nuisance because they nest over light fixtures in doorways. Then they "defend" their territory against people trying to pass through the doorway. To solve this

problem, staple a small piece of clear plastic above the light fixture after knocking down the nest. The plastic will prevent mud from sticking to the wall. The nest should only be removed after the young have fledged. Then place a nesting shelf nearby on the house or garage wall so it is at least 10 or 20 feet from the doorway.

## Eastern Phoebe

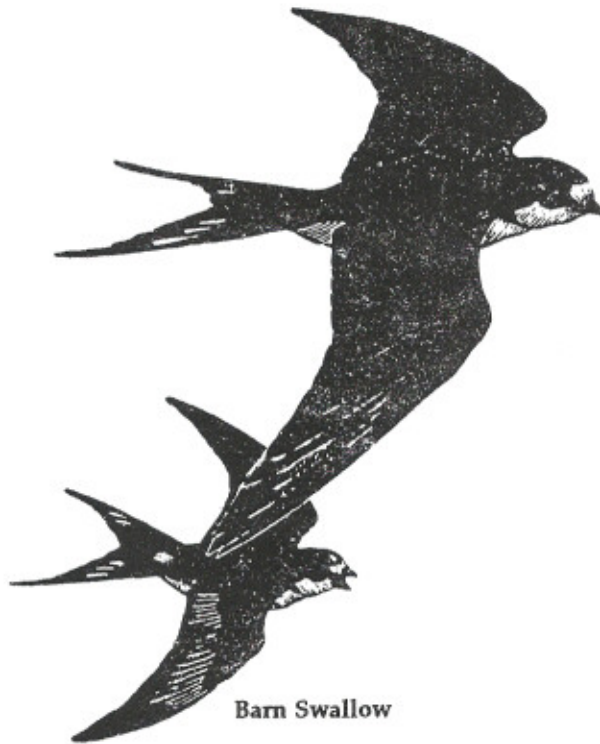
(Figure 6)

The eastern phoebe is a small gray songbird which usually feeds on insects while flying over water. Phoebes sit on low branches overhanging the water of a pond or creek; then make a short abrupt flight out over the water to catch insects.

Phoebes often build their nests on nesting shelves under the eaves of lake homes or cabins. The delicate nest is a beautiful cup-shaped structure made of mosses and lichens. The phoebe's call is a distinctive buzz-like "free-bee."



Eastern Phoebe



Barn Swallow

## Purple Martin

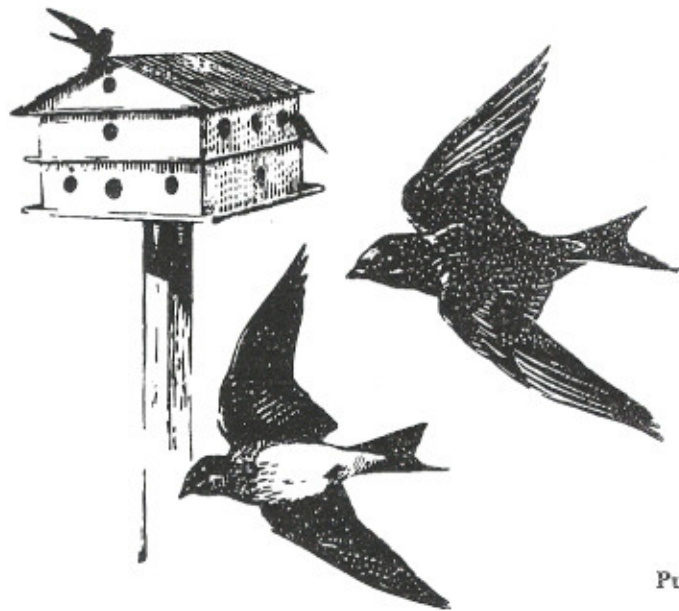
(Figure 7)

Attracting purple martins is the ultimate challenge to a backyard bird enthusiast. Some people will put up a martin house in the spring and attract martins with relative ease. Other persons may maintain martin houses for years in apparently good habitat with no luck in attracting them.

The purple martin is the largest member of the swallow family. It eats flying insects. Males are glossy black with purple iridescence. The markings of the female are somewhat duller.

The wooden purple martin house design should be modified to add a 1/2-inch diameter maple dowel "fence" around each balcony to prevent baby martins from falling off the balcony. If they fall to the ground, they will not be fed by their parents.

There follows an itemized list of instructions for making this purple martin house.



Purple Martin

## CONSTRUCTION

**Note:** This unit is held together by a threaded rod extending from the underside of the 1" x 2" base frame through the center of the chimney.

1. Mark all pieces on plywood sheet, then cut them out. Make four 1" x 1" x 5 7/8" corner blocks and eight 1" x 1" x 2" blocks to position the parts.
2. Cut out and assemble base from 1" x 2". Use 7d galvanized siding nails. Attach floor piece to base with glue and 1" or 1 1/4" nails.
3. Assemble the sides, alternating three hole and one hole pieces. Use glue and 1" nails or 3/4" #6 flat head wood screws. Use three at each end of each piece.
4. Position first-story sides on base piece. Mark position for each 1" x 1" x 2" block to hold side in position. Attach blocks to floor with glue and two 1" nails or 3/4" #6 flat head wood screws. Place completed sides in position on floor. Insert partitions. Position ceiling and mark for the location of 1" x 1" x 2" blocks near corners on the underside. Attach the blocks.
5. Place ceiling in position.
6. Glue pairs of end roof supports to-

gether to form gable ends 1/2" thick. Attach screen. Position and mark. Glue the two center roof supports together to make it 1/2" thick. It will be positioned adjacent to the threaded rod going up through the exact center of the house. Attach these pieces to the ceiling with glue and nails or flat head wood screws from the underside. Attach roof sides with glue and nails or screws.

7. Make chimney from a piece of 2" x 2". Cut V-notch on end to fit roof. Have it extend 2 1/2" above roof peak. Drill 1/4" hole in chimney and roof for rod. Nail chimney in place. Insert rod and tighten up.
8. Drill hole in top of pole to accommodate nut on lower end of threaded rod.
9. Use 1/2-inch diameter maple dowels to make a fence about 2-inches high on each balcony. Pieces of wood 1" x 1" x 3" may be used as the corner posts of this railing.

## MOUNTING

Use four 4" x 5" shelf brackets with 1/4" or 3/16" x 1 1/2" round head stove

bolts and 1" #8 flat head wood screws to attach to pole.

**Note:** Additional stories may be added if desired. One ceiling unit, four-sides, four-room partitions, eight 1" x 1" x 2" blocks, and four 1" x 1" x 5 7/8" corner blocks will be needed for each additional story.

Do not paint the interior of the house. Lightweight roofing paper makes an efficient roof covering. When painting the house, use aluminum paint on the roofing paper before painting it white. This seals in the black tar of the paper.

Commercially made aluminum houses are acceptable if they are well ventilated, have at least six compartments, with each compartment at least 6" x 6" x 6" in size. The entrance holes should be 2 1/4 inches in diameter and the bottom of the holes should be 1 inch above the floor.

Purple martins arrive in Tennessee from about March 5 to 25. As soon as the first martins, or "scouts" are seen, remove entrance covers from the martin house. The covers are used to keep sparrows and starlings out during the winter. If a cold spell hits after the martins arrive, insects will die and martins can starve. To help, place crushed egg

shells on a flat, elevated surface near the martin house. Another special inducement is a 1' x 2' area of soaked, unsodded earth which provides them with a "mud puddle" for a water supply.

Purple martin houses should be placed in an open area where the birds have clear access from all sides. The house should be at least 30 feet away from trees. Martins seem to prefer sites where utility wires are nearby for perching. Houses near open water, like lakes, may have added appeal but this is not essential. Martin houses should be painted white or a light color to reflect the sun's heat.

Most people suggest placing purple martin houses from 12- to 18-feet high. See Item 23 of the General Instructions section concerning predator guards.

A martin house can be taken down, cleaned and stored at the end of the summer, or the entrances should be covered as soon as the martins leave, usually in August. If a martin house is left up, the nesting cavities still need to be cleaned out.

There are several additional tips to enhance the possibilities of attracting purple martins.

1. You cannot have purple martins and house sparrows because the sparrow is the martin's worst enemy. The best way to control sparrows is to trap them. See Item 16 of the "General House and Platform Instructions" concerning a sparrow/starling trap.
2. In spring, when putting up a martin house, place a handful of wood chips or sawdust in each compartment.
3. Put a pinch of 1 percent rotenone powder on top of the wood chips. The rotenone keeps out or kills the lice. Lice or red mites will otherwise kill or harm the young martins.
4. Spread alfalfa broken into 4- or 5-inch lengths on a bare spot near the house so the martins can use it for nesting material.
5. During the period when the young birds are being fed by the parents, spread crushed egg shells on a bare spot near the martin house. This provides calcium for the young birds.
6. To keep sparrows under control, pull their nests out of the martin house with a wire hook. Do this in mid-afternoon when most of the martins

are at a pond or river for bathing or feeding.

7. Make sure the bottom of the compartment entrance holes are no more than 1 inch above the floor. This allows the young birds to get in and out to try their wings before they are ready to fly.

## Northern Flicker

(Figure 8)

Northern flickers are a common woodpecker across Tennessee. They frequently nest in farm groves, orchards, woodlots and in urban areas. Unlike most other woodpeckers, flickers usually forage for ants and grubs on the ground in crop fields and in grassy meadows and yards.

The "secret" of success in attracting flickers is to use 1 1/2-inch thick cedar boards for nest boxes and to fill the interior of the box all the way to the top with sawdust. Tamp in the sawdust before mid-March. This house should have a hinged roof to facilitate filling it with sawdust. The filled box simulates a dead tree with soft heartwood. The northern flicker is a "primary excavator." That means it will start at the entrance hole, which is provided, and throw out sawdust until a suitable cavity is created. Since this box remains filled with sawdust if it is not used, sparrows and starlings are not a problem. The entrance hole should be 2 1/2 inches in diameter.

Place flicker boxes 4- to 6-feet high along fence-rows that border crop fields or pastures. Or they may be placed in orchards and woodlots. Flicker boxes can be attached to existing fence posts or to free-standing posts with predator guards.

## Barn Owl

The once common barn owl has become rare. Declines have been linked largely to conversion from grass-associated agriculture to intensive row crop farming, especially soybeans. These birds feed primarily on small rodents found in dairy pastures, marshes, wet meadows and similar short-grass habitat. Their nests are ordinarily found in



Northern Flicker



Barn Owl

hollow trees, barns, silos and other buildings.

The barn owl has a heart-shaped face, small dark eyes, a dark tan back and a speckled white underside. They may nest throughout the year, especially from March to September. No nest is built. They generally have five to six purely white eggs laid at intervals of two to three days. Two broods are likely during one year.

The best known way to help restore the barn owl is to install nesting boxes within approximately one mile of their favorite hunting habitat. Research in Ohio and New Jersey has demonstrated that the following is the most effective of several different nest box designs for barns and most buildings. Plywood of 1/2- to 3/4-inch thickness can be used. The box should be about 40-inches long, 16-inches high and 12-inches wide (see Figure 9). It is closed with a hinged top, but no front. It is mounted against the inside wall of a barn or building, which acts as the front of the box. A 6- to 6 1/2-inch hole is cut through the barn wall and about 6-inches above the box floor and near one end of it for the birds to enter. The entrance way should be 20 to 25 feet above the ground. A clear flight path to the box opening should face open fields and be within one mile of the owl's normal feeding areas (dairy pastures, wet meadows, or other grasslands).

A slightly different box design is needed for silos (and other abandoned buildings) when it is not feasible to cut an entrance way through the wall. If there is a top opening for entry into the silo, construct a front for the box. The box top for this situation is cut in half across its width and hinged between the two sections. The top section resting over the box entrance is liftable and latched to the box inside; the other end of a the top is nailed in place. Design a "healthy" 6- x 6-inch box entrance to face the center of the silo. Hang this nesting box inside the silo from the top of the climbing-well.

These nest boxes may sometimes be adapted for use on trees or as uncovered trays when hung high in a silo. However, the young owls tend to fall from the tray more than from a box. This nest box does not work well at farmsteads with large numbers of pi-

geons, which can readily use the boxes and thereby worsen pigeon problems.

This description is based on research by Bruce Colvin of Bowling Green State University of Ohio and by Paul Hegdal of the U.S. Fish and Wildlife Service.

## Bats

(Figure 10)

Who in the world would think of building a house for bats? The idea sounds farfetched. Once bats are understood, however, their desirable qualities exceed even those of the popular purple martin. For example, some people claim that purple martins eat up to a thousand mosquitoes per day. Other persons dispute that total, saying that the daily total of mosquitoes is much lower because martins don't actively feed when mosquitoes are most active. In contrast, bats do. A single, big, brown bat can eat 3,000 to 7,000 mosquitoes each night! And a big brown bat can live up to 19 years. Bats are also devoted parents.

Expectant mother bats join together in "nursery" colonies where hundreds or thousands congregate to raise their young. Mother bats help each other with rearing young, and each female recognizes her own offspring. The big brown bat raises just one pup per year. Males cooperate during this reproductive phase by either bringing food to their mates or leaving the maternity cave to reduce competition for limited food supplies—depending on the species.

Since bats are such an important form of natural control for insect pests, like mosquitoes, it is in our best interest to perpetuate them. This is already being done in much of Europe where bats are totally protected and where people build "bat houses" much like we build martin houses. Figure 10 shows a European-style bat house.

The most likely occupants of bat houses are the big brown bat and little brown bat. The most critical dimension is the 3/4-inch width of the entry space. All inner surfaces must be roughened



Big Brown Bat

with a chisel or saw cuts to permit bats to climb on them with ease. Rough outer surfaces are also preferred.

Bat houses should be securely fastened to a tree trunk or the side of a building roughly 12 to 15 feet above the ground. Preferably they should be on the east side of the house or tree where they will receive the morning sun but will be shaded during the afternoon. Bats also seem to prefer sites that are protected from the wind.

The best habitat for bat houses is relatively near rivers, lakes, bogs, or marshes where insect populations are high. The closer bat houses are to such places the greater the probability that they will be used.

Bat houses should be placed by mid-March, but it may take a year or two for the bats to find the house. Once used, it does not need to be cleaned.

Chances of occupancy are better if bats already live in nearby buildings.

Another technique that may work to attract bats is to nail a 2-foot wide piece of tar paper around a tree trunk. Nail the tar paper around the top edge, like a tight-fitting skirt. This will prevent water from leaking under the paper from above. The bats will enter from below and can cling to the bark of the tree. To regulate their body temperature they can move laterally around the tree trunk as the sun moves during the day.

Sometimes bats create severe problems for people by establishing huge colonies in the attics of homes. The best way to solve this problem is to hire a carpenter in the winter to exclude bats at the holes where they enter the house. Since most bats migrate, it is possible to exclude the bats while they are not present.

Sometimes it is possible or desirable to set up an alternative bat house so they don't take up residence in someone else's house.

A Missouri-style bat house is appropriate for large bat concentrations. Such houses may be useful at state parks or on other public park and wildlife lands where bats may be causing problems in residences or outbuildings. A blueprint for the Missouri-style bat house is available from the Missouri Department of Conservation, P.O. Box 180, Jefferson City, Missouri 65102.

*This information on bats and bat houses has been provided by Dr. Merlin D. Tuttle of Bat Conservation International, Inc., c/o: Milwaukee Public Museum, Milwaukee, Wisconsin 53233.*

## Gray and Fox Squirrels

(Figure 14)

Gray and fox squirrels readily adapt to nest boxes in backyards, woodlots and farm groves. Gray squirrels tend to be found more in urban areas and in larger stands of hardwoods. Fox squirrels are found more commonly in farmsteads, river bottoms and woodlots.

A squirrel nest box is identical to the wood duck box shown in Figure 14, except for the location of the entrance hole and the ventilation holes. A 3-inch

diameter entrance hole is placed to the upper rear portion of one side. It is centered 3 1/2 inches from the top and 2 1/2 inches from the back edge. Ventilation holes are drilled into the side opposite the entrance.

Place the houses at least 30 feet above the ground in trees that are at least 10 inches in diameter. The entrance hole should face either east or south to be downwind from prevailing winter winds. A squirrel nest box can be made more enticing to squirrels by filling it half full of dry leaves. To attach the box to the tree, use a lag screw and washer at both the top and bottom of the back piece. Lag screws must be loosened annually to allow for tree growth. Wire should not be used because it can girdle the tree. Boxes are most heavily used in the winter, so new boxes should be set out in the fall. It is not necessary to clean out squirrel nest boxes.

One or two squirrel boxes per acre in a woodland are usually sufficient to maintain a maximum squirrel population.

## Raccoon

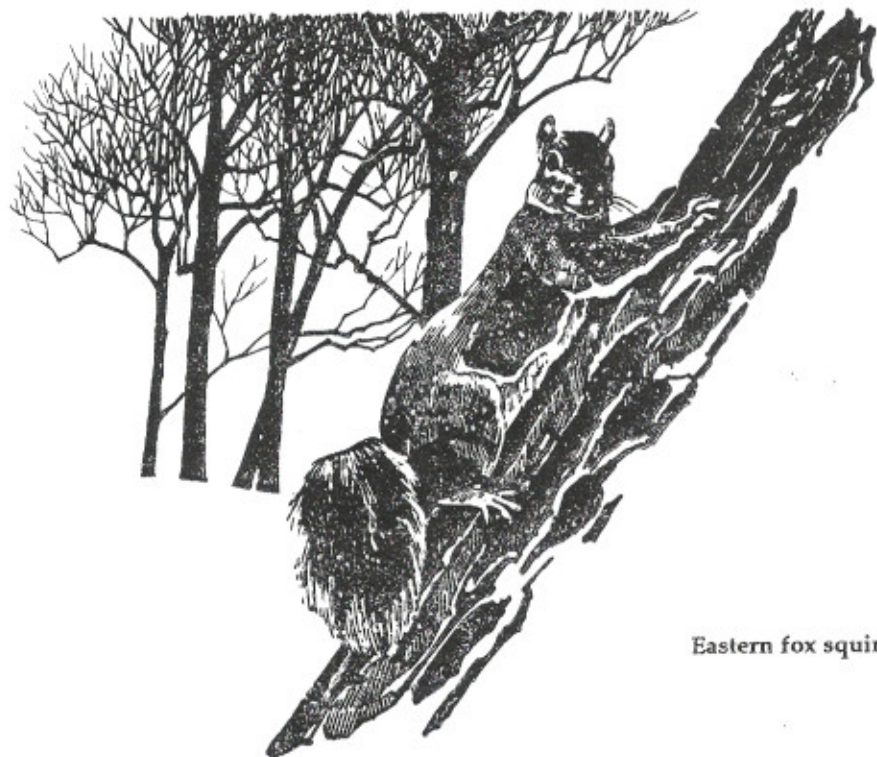
(Figure 14)

The raccoon is a common mammal across most of Tennessee, with fewer found in the eastern portions of the State. Most nest box projects are de-

signed to exclude use or predation by raccoons. If someone wishes to provide a box which can be used by raccoons, however, the design in Figure 14 is suitable. The entrance hole should be 5-inches high and 9-inches wide and face east or south so it is sheltered from winter winds. Place the box on a tree (either live or a dead) that is at least 12 inches in diameter and at a height of 10 to 20 feet.



Raccoon



Eastern fox squirrel

## Part 2:

# Nest boxes and platforms for use in extensive stands of deciduous or coniferous forest

## American Kestrel

(Figure 12)

The American kestrel (formerly called sparrow hawk) is our smallest falcon and is abundant in agricultural areas characterized by scattered woodlots, scattered trees, meadows, highway rights-of-way, pastures and hay fields. This species is valuable because of the large numbers of rodents and insects it eats. Kestrels are frequently seen sitting on powerlines along highways or hovering above the grassy roadside ditches in search of their prey. An adult kestrel is about the size of a grackle.

Iowa has a program in which kestrel nest boxes are placed on the back of information signs along Interstates. The boxes are predator proof because the steel posts supporting the signs can't be climbed by cats or raccoons. The grassy interstate right-of-way is ideal habitat for kestrels. The boxes are strapped to the vertical sign posts with steel bands by using a steel-banding tool normally used for strapping steel bands around freight.

The nest box shown in Figure 12 is excellent for kestrels. Place the box in orchards or relatively open country on a tree or a free-standing post 10- to 30-feet high and spaced one-half mile from each other. The tree or post should have a sheet of tin or aluminum nailed or stapled around it, under the box, to prevent access by squirrels and predators. Used aluminum offset printing plates can be purchased very cheaply from newspaper offices for this purpose. The nest hole should be 3-inches in diameter and preferably face south to east. Place about 2 to 3 inches of wood chips in the bottom of the box, and be sure there is grassy habitat in the vicinity to provide hunting habitat for the birds.

Starlings may be a persistent problem in a kestrel box. The boxes will need to be checked every week or ten days to

remove starling eggs and nests. Starlings are not a native American species and so are not protected in this State.

Kestrels normally lay five white, pinkish-white, or cinnamon-color eggs evenly covered with small spots of brown. Occasional checking of the nest will not cause the kestrels to abandon the site.

## Barred Owl

(Figure 11)

The barred owl is one of our more common raptors in hardwood forests. Its call is a distinctive "Who-cooks-for-you" and its brown eyes with blue pupils are unique. The barred owl nest box is made of 3/4-inch thick exterior grade plywood. Do not paint, stain, or treat the box with creosote. Put a 2- to 3-inch layer of small wood chips in the bottom. The entrance hole is 7-inches wide and 7-inches high with a rounded top and rounded corners at the bottom. The hole can be either on the front or on a side, but if it is on the side the box is easier to clean. No actual cleaning is needed except to remove the leaves and other litter that squirrels put in. This box can be cleaned through the entrance hole, so the roof does not need to be hinged.

Squirrels may take over the barred owl nest box (see Figure 11). If you have a problem, try removing the roof of the box since squirrels are less prone to use a topless nest box.

Another effective design for barred owls is to use the wood duck pattern in Figure 14 with the following modifications: Make the front and side 18-inches long, not 24 inches. The back should be 26-inches long, not 32 inches and since you can leave the roof open, no entrance hole is necessary.

Any debris in the box should be cleaned out or a new box placed in January. The box should be located 20- to 30-feet high in a mature upland hardwood



Barred Owl

or lowland hardwood area, and preferably within 200-feet of water. The box should be placed on a living hardwood tree or a conifer with a relatively open, exposed trunk, and they need to be spaced one-half mile from each other because the barred owls defend a territory of 400 to 600 acres per pair.

The entrance hole should not be obscured by branches or leaves, but a perch near the nest box is desirable. This perch should be near enough so the young can "branch" out onto it as they leave the nest. Ensuring an open flight path is also highly desirable. Owls typically have a low level flight path with an upward swing to the box entrance or nearby branch. Removal of a few small trees in front of the box allows easier access.

Placement of boxes can help prevent predation. Don't put them near major game trails, on the edge of a clearing or within 150 feet of a residence. Raccoon predation can be reduced by placing a 2-foot wide sheet of aluminum around the tree at chest height.

## Great Crested Flycatcher

(Figure 4)

This fascinating songbird of our hardwood forests, orchards, and parks is grayish above with a yellowish breast. It is more often heard than seen. The call is an ascending loud whistle "Wheeeep!" The nests are often characterized by the presence of shed snake skins which have been placed there by the flycatchers. The bulky nest also includes twigs, leaves, hair, feathers and bark fibers.

Great crested flycatchers will use the one-board bluebird house in Figure 4, except the entrance hole should be 1 3/4-inches in diameter. Chances of use are best if the house is placed from 10- to 20-feet high. These birds tend to use nest boxes in pine trees in mixed conifer and hardwood stands.

Newly fledged flycatchers are a real treat to see. They cling to the side of trees like fuzzy little woodpeckers.

## Prothonotary Warbler

(Figure 1)

This warbler is orange-yellow with wings and tail that are slate-blue. It is found in bottomland hardwood forest and along river valleys.

It often nests in flooded backwater habitats that are characterized by woodland pools and oxbow ponds. Its nest is typically an abandoned downy woodpecker hole in a dead willow snag in standing water. Often the nest will be no more than 3 to 5 feet above the water level.

Most people don't realize that this beautiful woodland warbler is rather adaptable and will also use birdhouses.

If you live in lowland hardwood forest habitat, try using the birdhouse plan in Figure 1. Use a 1 1/4-inch diameter hole. This will exclude use by house sparrows. Place the houses on a snag or post in shallow woodland pools or in oxbow ponds of river bottom habitat, 3 to 5 feet above water level. If predator guards are used on free standing posts, nests can also be placed on adjacent shoreline habitat with the hole facing the open water. Prothonotary warblers will also nest in these birdhouses if they are placed on the sides of homes or outbuildings near water.

## Eastern Screech-owl

(Figure 12)

Eastern screech-owls are small gray or reddish owls with ear tufts which live in our hardwood forest. They are only about 8-inches high and resemble a miniature version of the more common great horned owl. Place the nest box for screech owls shown in Figure 12 at least 10-feet high in a hardwood forest. Preferred habitat seems to be on the edge of woods adjacent to fields or wetlands. To prevent use by squirrels the box could be placed on a pole with a predator guard. Since the entrance hole is 3 inches in diameter, persistent starling control may be necessary. Place about 2 to 3 inches of wood chips in the bottom of the nesting box.

## Northern and Southern Flying Squirrel

(Figure 12)

The spritely flying squirrel is nocturnal and is seldom seen even where it is a common resident. They may come out at night to feed in backyard bird feeders. Flying squirrels are found in a wide variety of habitats ranging from coniferous forests to groves and woodlots. They readily use boxes set out for other species, including wood duck and screech owls. The screech owl box in Figure 12 is an especially good size for flying squirrels.



Flying Squirrel

## Eastern Red Squirrel

(Figure 12)

The eastern red squirrel, like the flying squirrel, is adaptable to a wide variety of habitats ranging from coniferous forests to farm woodlots. The screech owl box in Figure 12 is appropriate for use by eastern red squirrels, and they will also use wood duck boxes. They are extremely aggressive at bird feeders and regularly eat the eggs and young of songbirds. For these reasons, they are not among the more favored tenants of nest boxes.



Eastern Red Squirrel

## Great Horned Owl

(Figure 13)

The great horned owl is one of Tennessee's most common owls. It is found in an incredible variety of habitats ranging from farm woodlots and shelterbelts to large stands of hardwood forest. Since owls do not construct their own nests, they readily adapt to "nesting platforms" that are placed in a suitable site.

The great horned owl nesting platform is made by using a 3' x 3' piece of 1-inch mesh chicken wire. The chicken wire is made into a shallow cone by cutting from one corner to the center and then overlapping the two cut edges until the cone is about 18-inches deep. The cut ends of the wire are then bent around the overlapping section, lined with tar paper and then provided with a drainage hole at the base. Nest material, consisting of twigs, leaves, and branches,



Great Horned Owl

with finer material near the top, is added to the cone. Larger branches are interwoven with each other and the chicken wire as tightly as possible. Flexible shrubs like willow and dogwood are excellent for weaving around the top edge of the nest so that a solid interwoven nest structure is created—not just a pile of sticks. The completed nest is then tied to a rope, pulled up to a tree, and secured in a suitable crotch with wire and/or large staples. Nests should be put out in the fall if they are to be located and used by great horned owls the following January.

Great horned owls usually nest in red-tailed hawk nests that are about 45-

feet high. They will nest lower, however, and would likely accept nest platforms that are 15- to 20-feet high. Place the nest platform in a live hardwood tree at least 12 inches in diameter. Good sites would be remote corners of farm groves or large trees in shelterbelts and farm windbreaks. A key feature to look for is a crotch that would facilitate placement of the platform.

One reason people may wish to attract great horned owls is to help remove cottontail rabbits in orchards or farm groves where shrubs are being damaged. Also, these owls are one of the only predators that regularly eat skunks. This is particularly important where skunks are the main carrier of rabies.

*This nest design is provided by Bob Bohm from the following article: Bohm, R.T., 1977. Artificial Nest Platforms for Raptors. Raptor Research 11(4):97-99.*

## Pileated Woodpecker

(Figure 14)

The distinctive pileated woodpecker is the largest woodpecker in Tennessee—about the size of a crow.

It has not been known to nest in nesting boxes because it is a primary excavator and must dig its own nesting

cavity. However, the breakthrough in attracting flickers developed by Mr. A. J. Boersma of Sioux Center, Iowa, may apply to pileated woodpeckers also. The "trick" is to fill the nest box with sawdust all the way to the top and tamp it in. Then the woodpecker can fulfill its instinct to make its own nest cavity.

This nest box design is proposed as an experiment for woodland owners, naturalists and biologists to try. Use the one-board wood duck box design shown in Figure 14, but use 1 1/2-inch thick cedar instead of a 3/4-inch thick board as you would for a wood duck house. A 12-foot long, 2" x 12" board will be necessary to make this box.

Remember that the floor section must be 8 1/4-inches long instead of 9 3/4 inches as shown in Figure 14.

Make the entrance hole 4 inches in diameter and centered 19 inches above the floor. The top should be hinged to allow filling with sawdust. Set the box so the entrance faces south or east.

Place the box about 20 to 30 feet up either a live or dead hardwood tree in the interior of a stand of mature hardwoods where pileated woodpeckers are known to live. Attach the house to the tree with lag screws and washers which can be loosened as the tree grows. Caution: Dead trees are often unsafe to climb and may frequently be undesirable to use for that reason.

### Part 3:

## Nest boxes and platforms for use near lakes, rivers, marshes, ponds and adjacent upland habitats

### Wood Duck

(Figure 14)

The traditional wood duck box has helped the beautiful wood duck make a remarkable recovery during the past 30 years. Early in this century some people believed the wood duck was on the verge of extinction. Now it is one of our most abundant waterfowl species.

As shown in Figure 14, the entrance hole should be an oval 3-inches high and 4-inches wide. This hole excludes most raccoons. Center the hole 19 inches above the floor. Cut out an 18" x 3" strip of 1/4-inch mesh hardware cloth and fold the cut edges back. This should be attached inside the box under the entrance to function as a ladder for the newly hatched ducklings. Sometimes squirrels will tear this ladder loose so it needs to be checked annually. Or roughen the wood under the entrance hole with a chisel to give the ducklings the toe-holds they need. The roughened area should extend below the entrance hole for 1 foot. Place at least 3 inches of mixed sawdust and chain saw wood chips in the nest for nesting material. Use paired roofing nails with large heads around the top of the box to wire it shut so raccoons can't open the box and yet it can be opened for maintenance.

Use wood that is strong and can be made weather resistant. Painted, stained, or treated it, but on the outside only. Recess the floor 1/4 inch up from the lower edge of the sides to prevent rotting.

Wood duck houses can be erected on an isolated tree or on a 16-foot long, 4" x 4" post of cypress, cedar or preservative-treated wood. An aluminum or tin sheet must be nailed around the post under the house to prevent squirrels and raccoons from entering. Used aluminum printing plates from newspaper offices can be purchased very cheaply and stapled length-wise to the 4" x 4" post under the nest box. Since

wood ducks are not territorial, two or more houses can be placed on the same post or tree.

Formerly, wood duck boxes were widely scattered throughout woodland areas near water. These boxes were difficult and inefficient to service. It is more practical—and effective—to cluster the nest boxes in a small area for ease of maintenance. For example, placing and monitoring 20 or 30 boxes in a 10- to 20-acre park-like woodland near a good marsh or lake complex would be an ideal location for intensive wood duck management by a sportsmen's club or conservation organization.

Vigilant starling control is necessary in wood duck boxes. Remove their nests and eggs whenever they occur. Fasten the top of a wood duck box to its support so that it leans forward 2 inches. This facilitates the drainage of rainwater. To strengthen the box, nail a 9 3/4-inch long 1" x 2" along the inside top edge of the front. Nail a similar size piece onto the back just under the area where the roof rests.

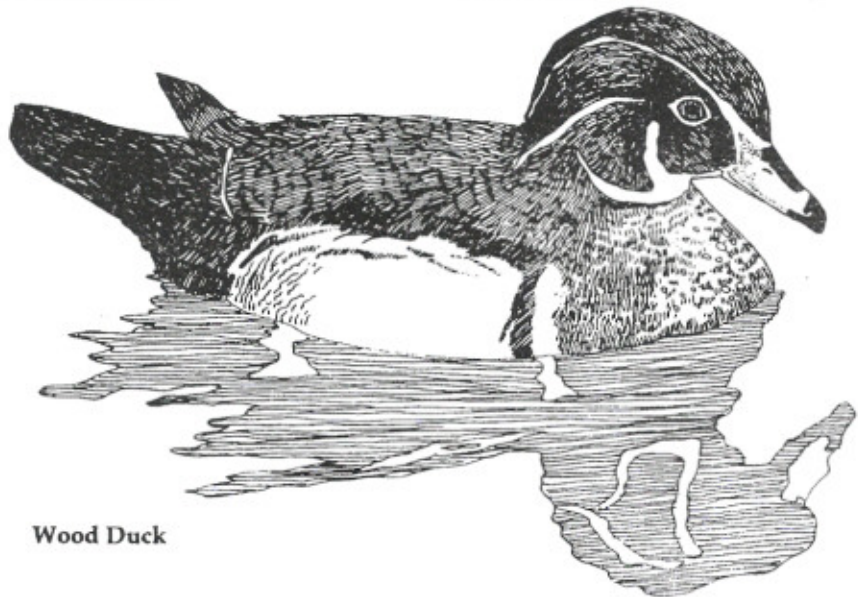
Place a horizontal piece of slab wood with the bark attached on the front of the box immediately below the entrance hole. This aids the hen in landing and entering the hole.

Wood duck boxes should be placed over water or in woodland habitat up to one-half mile from lakes, ponds, marshes and rivers. Boxes placed in water should be mounted on posts about 6 to 8 feet above the water's surface. Since the hen must lead her ducklings to water after they hatch, the habitat between the house location and the water's edge need to be free of major obstacles like highways, fences with small mesh wire and street curbing.

In trees, box heights above 20 feet seem to be preferred. Box entrances near water should face the water. Otherwise, there seems to be a slight preference for south and west facing entrance holes. Ideally, boxes on land should be 30 to 100 feet from the water's edge. The chance of predation by raccoons is higher along the water's edge.

Annual maintenance on wood duck boxes should be completed by March 1. Open and inspect the boxes, adding more wood chips if necessary. You may wish to cut a small door into the side of wood duck boxes so you can easily check them from the side. Make sure the door fits tightly, admits no sunlight or rain, and can be wired shut to prevent raccoons from entering.

When you service wood duck boxes in the spring, be adequately prepared. You will need a wrench for loosening the lag screws, a hammer, extra roofs, at least one sack of chain saw wood chips, nails, wire and an extension ladder. A rope would also be useful for raising new houses or lowering old ones for maintenance work.



Wood Duck

## Great Blue Heron

(Figure 15)

The great blue heron is one of our most conspicuous water birds. Found across the State, they are a colonial-nesting species, living typically in live or dead trees on shoreline woods. Usually the best management practice is to protect the colony from disturbance during the nesting season.

In some cases, however, herons will nest in dead trees in newly created reservoirs or in beaver ponds. These trees can be expected to deteriorate and fall within five to 15 years of flooding. When this happens on public land, it may be advisable to try to retain the colony there where it can be adequately protected, managed, and/or viewed by the public. Sometimes colonies on private land are more vulnerable to harassment, shooting by vandals or untimely wood-cutting activities that can jeopardize the birds.

Colonies in dead trees can be preserved in those locations by providing nest platforms on utility poles or dead tree trunks. Platforms constructed on new poles have a 45-year life expectancy.

The support poles should be at least 30-feet high and at least 6 to 8 inches in diameter at the base. These poles can be obtained new or used from local utility companies.

Three nest platforms can be placed on each pole. Space the platforms 4 feet apart and underneath each other. The top platform is placed at the top of the pole; each succeeding one should be placed at the top of its pole. Each platform is constructed as shown in Figure 15. Materials are pre-cut, bolt holes pre-drilled, and platforms semi-constructed before going into the field. This includes joining the top and bottom braces for each sidearm with machine bolts. The outermost nest support on the platform is attached to the sidearms with a 21 1/2 inch distance between nailing points. This presets the width of the platform. Final construction is done at the site where the poles are to be erected. As an added inducement for the birds, a small armful of branches could be wired on top of the platform to provide a more secure foundation for the heron's nest.

Soil quality and water depth determine the site to be used. The pole needs to be placed in a firm substrate. A clay substrate to a depth of 6 1/2 feet is acceptable. Water depth should be no more than 4 1/2 feet. Select sites in or adjacent to an existing colony.

A hole can be drilled into the soil with a hydraulic 8-inch auger mounted on the back of a utility company line truck. A 30-foot post requires a 6-foot deep post hole. The butt end of each pole can be pointed to facilitate sliding it into the hole. If a utility company auger truck can be contracted to do this work, it will have the hydraulic equipment necessary to raise the pole into the hole with the nests attached.

Sidearms are attached to the poles with lag screws. The lag screws are driven into the posts with a hammer. The nest platforms are set at approximately 7 degrees above horizontal to provide a pocket for nesting.

To maintain a colony of herons, it is desirable to place at least 20 poles. At three nests-per-hole, this is enough to sustain a colony of up to 60 pairs of birds.

## Double-crested

### Cormorant

(Figure 15)

The double-crested cormorant is a black water bird about the size of a goose. It has been increasing in numbers during the last five years. Cormorants readily utilize nest platforms like those explained for the great blue heron. They may nest in colonies with great blue herons or they may occur in colonies comprised of cormorants only. As with great blue herons, nest platforms should be placed in or adjacent to existing colonies.

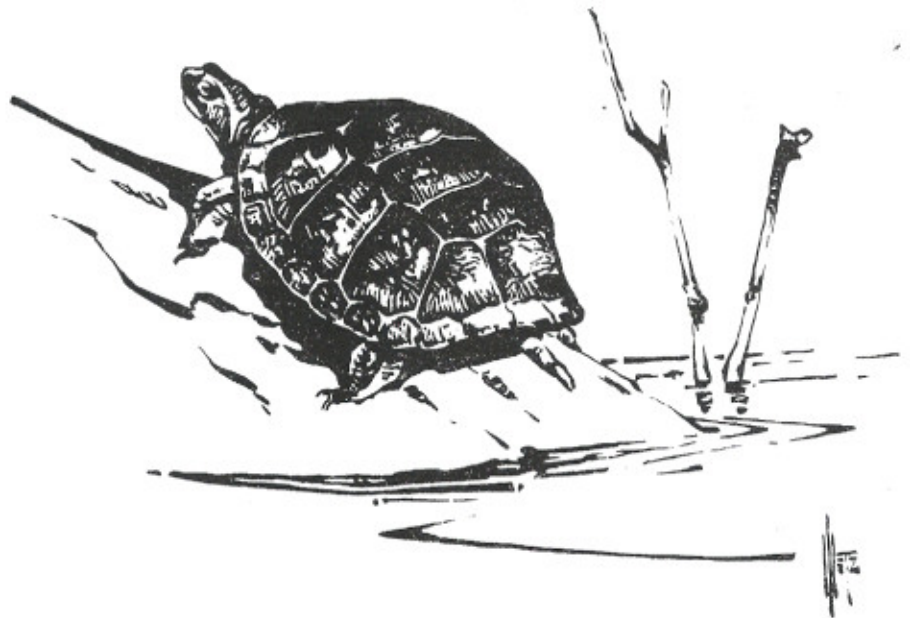


Double-crested Cormorant

## Turtle and Duck Loafing Platform

(Figure 17)

The type of platform described for Canada geese, minus the nesting tub, will work very well along sheltered lake shores and small ponds as loafing and sunning sites for turtles, wood ducks, mallards and blue-winged teal. The sites are important because they are relatively safe from predators. Strategically placed platforms can provide enjoyable viewing opportunities for people in front of their lake shore homes or at wetlands in parks and nature centers.



Turtle

## Osprey

(Figure 16)

The osprey, or fish hawk, can become very adapted to human presence and the use of nesting platforms. People living in beach front homes on the East Coast once placed old wooden wagon wheels horizontally on poles in their yards to provide nesting sites for ospreys.

Ospreys have been gradually increasing in Tennessee since the late 1970s. Their previous decline was attributed to the use of pesticides such as DDT. Ospreys nest on power line transmission towers, or in the tops of dead trees in beaver ponds, lakes and impoundments. The number of years a given nest may be used is usually limited because the dead trees rot and fall over.

If ospreys nest in a hazardous site on a transmission tower, it is possible to place a nesting pole and platform adjacent to the power line nest and move the chicks to the nest platform when they are perhaps four weeks old. The parents usually adapt to the new nest, and the old nest can be removed.

Nest platforms and poles can be constructed in the shoreline of lakes and large rivers. Or they can be placed at sites where the existing nest tree has fallen down. Platforms can be placed on old utility poles in open habitats or on "topped" super canopy trees, or on snags adjacent to a shoreline. Avoid developed or intensively used recreational areas.

Figure 16 is a diagram of an osprey

nest platform. Table 1 is a list of the items needed to construct it. A 6- to 8-inch diameter utility pole 15- to 30-feet high is adequate. Poles can be inserted in water sites using the techniques explained for the great blue heron nesting poles. Osprey nesting poles on land can be placed by using an auger and digging a 5-foot deep hole. All nail and bolt holes are pre-drilled to prevent splitting. The wire mesh is nailed in the platform. The whole structure is treated with wood preservative and stained brown. Steel braces are bolted to the platform; lag screws are used to secure the platform to the pole or topped pine

tree. Wire some sticks into the nest to help stimulate use by ospreys. Before installing an osprey nesting platform on T.V.A. or Corps of Engineers property, contact these agencies for a permit. Osprey nest platforms should be installed by April 1.

This information has been derived from F.L. Johnson and V. Wolniewicz, 1979. *Platform for Ospreys*. Wisconsin DNR Endangered Species Report, and from JoAnn Frier, *Artificial Nesting Structures for Osprey*. New Jersey Division of Fish, Game and Wildlife.

Table 1. Materials needed for Osprey Nest Platform.

- Two 2" x 6" x 12' cedar boards
- One 2" x 6" x 4' cedar board
- One 12" x 12" x 1/2" exterior plywood
- One 45" x 45" piece of heavy duty wire mesh
- Galvanized 40D nails
- One 6" or 8" diameter cedar post, 20' x 30'
- Wood preservative and stain

## Canada Goose

(Figure 17)

The Canada goose has made such a remarkable recovery in Tennessee during the past 30 years that in some locations little needs to be done to help ensure their nesting success. There may be local situations, however, where a landowner wishes to enjoy the presence of nesting geese on a particular lake or where fluctuating water levels in impoundments may jeopardize goose nests on muskrat houses or other natural sites. In such cases, a floating nest platform can be a useful alternative as shown in Figure 17.

To make this platform, cut three lengths of 8-inch diameter cedar poles 4-feet long. Lay the posts parallel in order to make a 4' x 4' platform on top of the posts. Nail 4-foot lengths of 2" x 6" boards perpendicular to the direction of the posts. Space the boards about 1-inch apart.

Next you will need a galvanized round metal washtub 22 inches in diameter and 10 1/2-inches high. These can be purchased at hardware or farm supply stores. A low budget alternative to a washtub is to wire an old tire to the platform and fill it half full of wood chips and sawdust after covering the slats in the platform beneath it. It is desirable to fit sheets of plastic foam under the platform to help keep it from sinking after it eventually becomes waterlogged.

Punch about 10 drain holes in the bottom of the washtub, and just under the rolled upper edge of the tub, cut an "escape hatch" 6-inches wide and 4-inches high. This is to prevent newly hatched goslings from becoming trapped inside.

Paint the tub an earth tone, nail it onto the center of the platform, and fill it one-third full with wood chips.

The platform can be towed out with a boat. Get it in place by March 1. The best locations are in relatively sheltered areas or bays and at least 200 yards apart if they are in view of each other to minimize territorial conflicts between nesting pairs. Nest platforms can be closer together if there are trees, peninsulas or other visual barriers between the platform sites. In relatively open water areas, it is best to have them within 20 to 30 feet of the shore.

The platforms should be placed in 2 to 4 feet of water. Bolt a length of welded link chain around the cedar posts on opposing corners of the platform. Make each chain 3-feet longer than the depth of the water from the high water mark to the bottom. Each chain should be bolted to an 8" x 8" x 16" concrete foundation block. The double anchor blocks are dropped about 6-feet apart to prevent the platform from constantly pivoting with the wind.

Place an armful of grass or wild hay in the nesting tub by early March to provide nesting material. Most goose nesting will occur from mid-March through early May.

## Cliff Swallow

(Figure 18)

The cliff swallow is an insect-eating bird. Usually it nests under the eaves of outbuildings, in culverts, on cliffs and under bridges. The gourd-shaped nest chamber has an opening tunnel extending outward. Each nest requires one to two weeks of construction and contains 900 to 1,200 mud pellets which are carried to the site in the mouths of parent birds.

Cliff swallow nests can occur in colonies of hundreds. Unfortunately, such colonies are subject to destruction by bridge and highway improvement projects, destruction during demolition of old buildings and competition by house sparrows, which attempt to use the nests.

If a colony is destroyed, it will probably be abandoned. However, if simulated nests are placed on the former colony site, the swallows will readily adapt. Providing groups of such artificial nests can be an effective mitigation technique at sites where a colony has been destroyed by construction efforts.

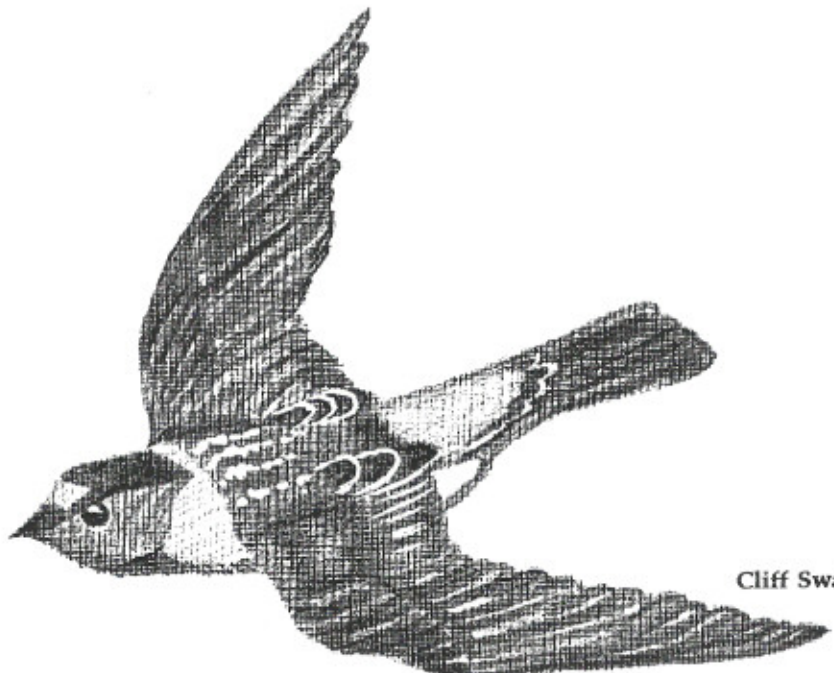
The artificial nests have one other advantage: Cliff swallow pairs are more likely to raise a second brood in an artificial nest. They normally need 40 to 43 days to lay their eggs and raise their young after the nest is built. By eliminating the 2-week nest building period,

there is enough time for a second family to fledge.

The following is the procedure necessary to create a cliff swallow nest: Select as a model a cliff swallow nest which is being used by a house sparrow, because house sparrow nests are not protected by federal or state law. Coat the nest three times with Blue Diamond Casting Plaster. Then remove the entire nest with a putty knife and wash the mud of the nest out of the plaster mold. Add additional plaster inside the mold to reduce the inside dimensions to those of a normal nest interior.

Fill the plaster mold with liquid latex, allow it to set for about 10 minutes and pour out the excess. This leaves a thin sheet of latex over the interior of the mold. When this latex sheet has hardened, remove it. The exterior of the latex mold is the exact duplicate of the interior of a cliff swallow nest.

Place the latex mold on a flat surface, front upward and set a collar of modeling clay around the entrance hole. This collar opens outward to a diameter of approximately 2-inches. Cover the mold with a 1/4-inch layer of wet casting plaster in the manner of frosting a cake but do not cover the entrance hole with the plaster. Any excess plaster can be trimmed with a knife before it dries. The nests can be strengthened by incorporating 1" x 6" strips of burlap into the



Cliff Swallow

plaster. It is easier to attach these nests to their support board if upper and lower "flanges" of plaster are created through which screws can be placed.

The plaster hardens in about 15 minutes. After it has hardened, strip the flexible latex mold from inside the artificial nest. The exterior of the nest will be relatively smooth in comparison to the natural nest.

The nest's waterproof qualities can be improved by sealing the plaster with acrylic or polyurethane spray paint. Coat the outside plus the inside edge of the entrance hole with mud to simulate the real nest. This type of nest will last at least two to three years. Attach the artificial nests in a horizontal line along a board, or clustered them on a sheet of plywood. Nests should be in place at the site of the former colony by April 1.

This technique was provided by the North Carolina Wildlife Resources Commission.

## Mallard

(Figure 19)

Nest baskets have been used for mallards for over 300 years in Britain and in the Netherlands. The oldest form of nest basket is the pitcher-shaped basket. The original Dutch version was woven of willow shoots. The baskets were placed on islands or on the mainland on posts or in the low crotches of trees. Baskets mounted 6 feet or higher above the ground were well used, and the entrance was tilted slightly upward.

This mallard basket idea has been modified in the Midwest into a nesting cone placed over water on a support pipe as shown in Figure 19. It was originally developed and evaluated by U.S. Fish and Wildlife Service waterfowl biologists Forrest B. Lee and Harold A. Doty of the Northern Prairie Wildlife Research Center at Jamestown, North Dakota. There is no universal agreement on whether or not nesting

cones are really necessary for mallards because they are so adaptable. Hal Doty recommends their use only in the open prairie pothole region (not in forested areas).

The nesting cone is a galvanized, 1/2-inch wire mesh cone, 12-inches deep with a 26-inch diameter open top. It is wired to a frame of welded, 1/4-inch diameter steel rods which are welded to a 26-inch length of pipe of a diameter that will fit snugly into a support pipe.

After assembling the basket and frame, line the inside with nesting materials. Straw is probably the best, but wild hay can be used. Nesting material may be placed in 2- or 3-inch thick even layers within the cone and tied in place with soft, pliable wire. About 6 to 7 inches of grass should be fluffed-up in the center of the basket.

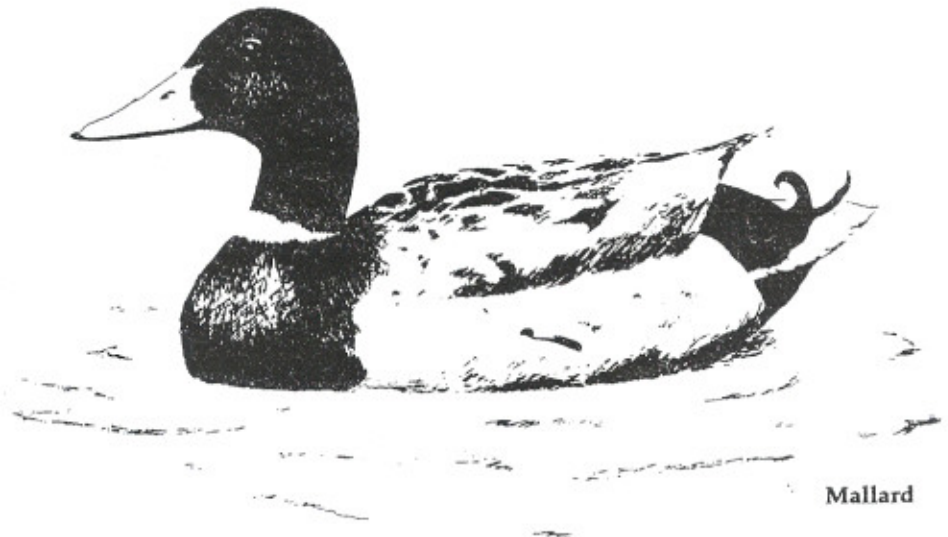
Tap a threaded hole for a setscrew about 3 inches from the top of the support pole. The tightened setscrew pre-

vents the basket from rotating and allows for raising or lowering the basket if the water levels change.

The support pole should be smooth to prevent predators like raccoons from climbing them. A 7- to 8-foot long support pole is usually adequate unless a marsh has a very soft bottom.

It is best to place baskets in marshes that are 2- to 4-feet deep, and where water will remain at least through mid-summer. Set the baskets in small openings among the cattails and bulrushes, but more than 10 feet from the shore. The top of the basket should be 3 1/2 to 5 feet above the water surface. Baskets need to be in place by mid-March. They need to be checked and maintained each year by that date.

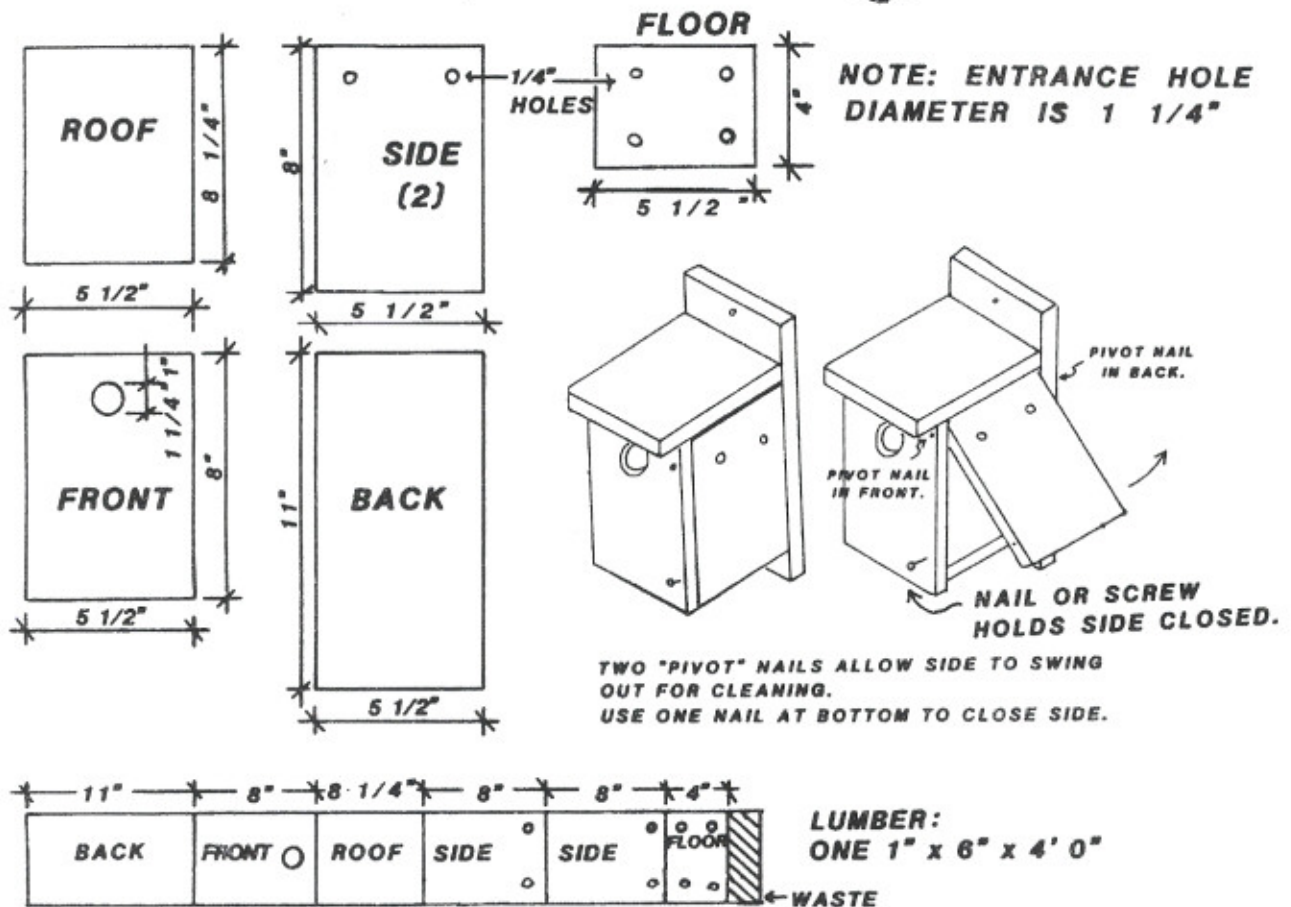
This information was obtained from Art Hawkins, retired, U.S. Fish and Wildlife Service, Hal Doty, and from the publication *New Homes for Prairie Ducks* by the U.S. Fish and Wildlife Service.



Mallard

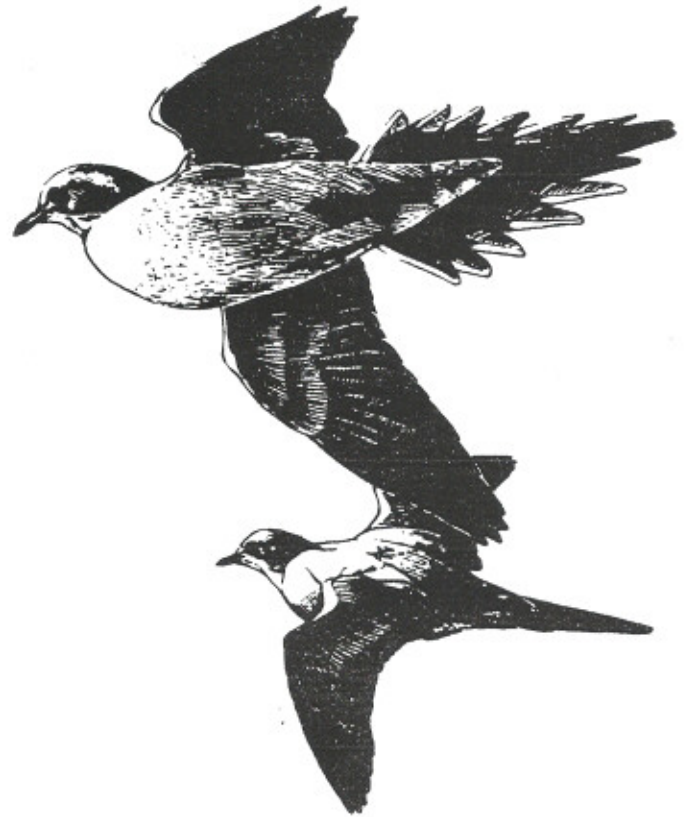
FIGURE 1

HOUSE WREN  
 CAROLINA CHICKADEE  
 WHITE-BREASTED NUTHATCH  
 PROTHONOTARY WARBLER  
 NEST BOX

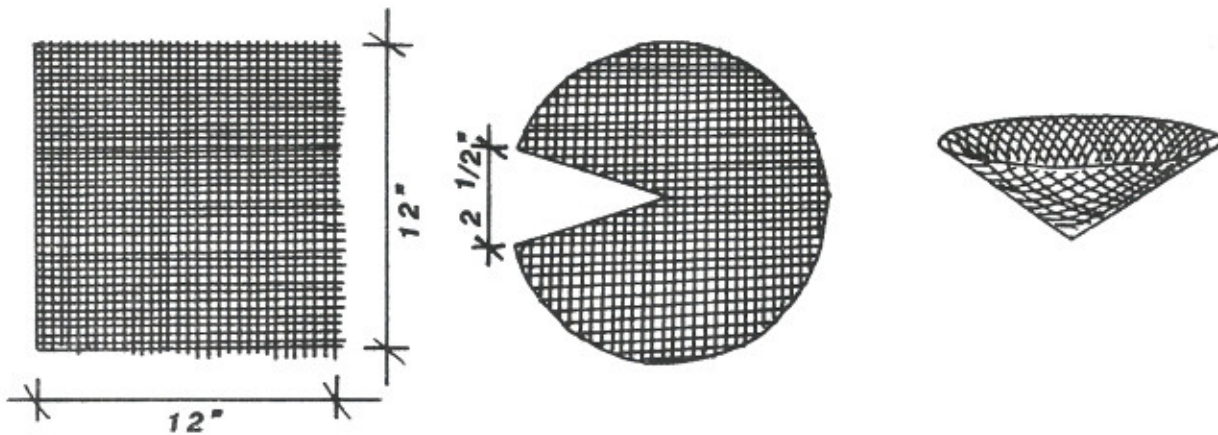


**FIGURE 2**

**MOURNING DOVE NEST BASKET**



**MATERIALS: ONE 12"x12" PIECE OF HARDWARE CLOTH.**



*Cut with tin snips to form a circle. Cut out a narrow pie-shape and wire edges together to form a cone. Wire and/or staple cone into the crotch of a tree limb.*

FIGURE 3

PETERSON BLUEBIRD HOUSE

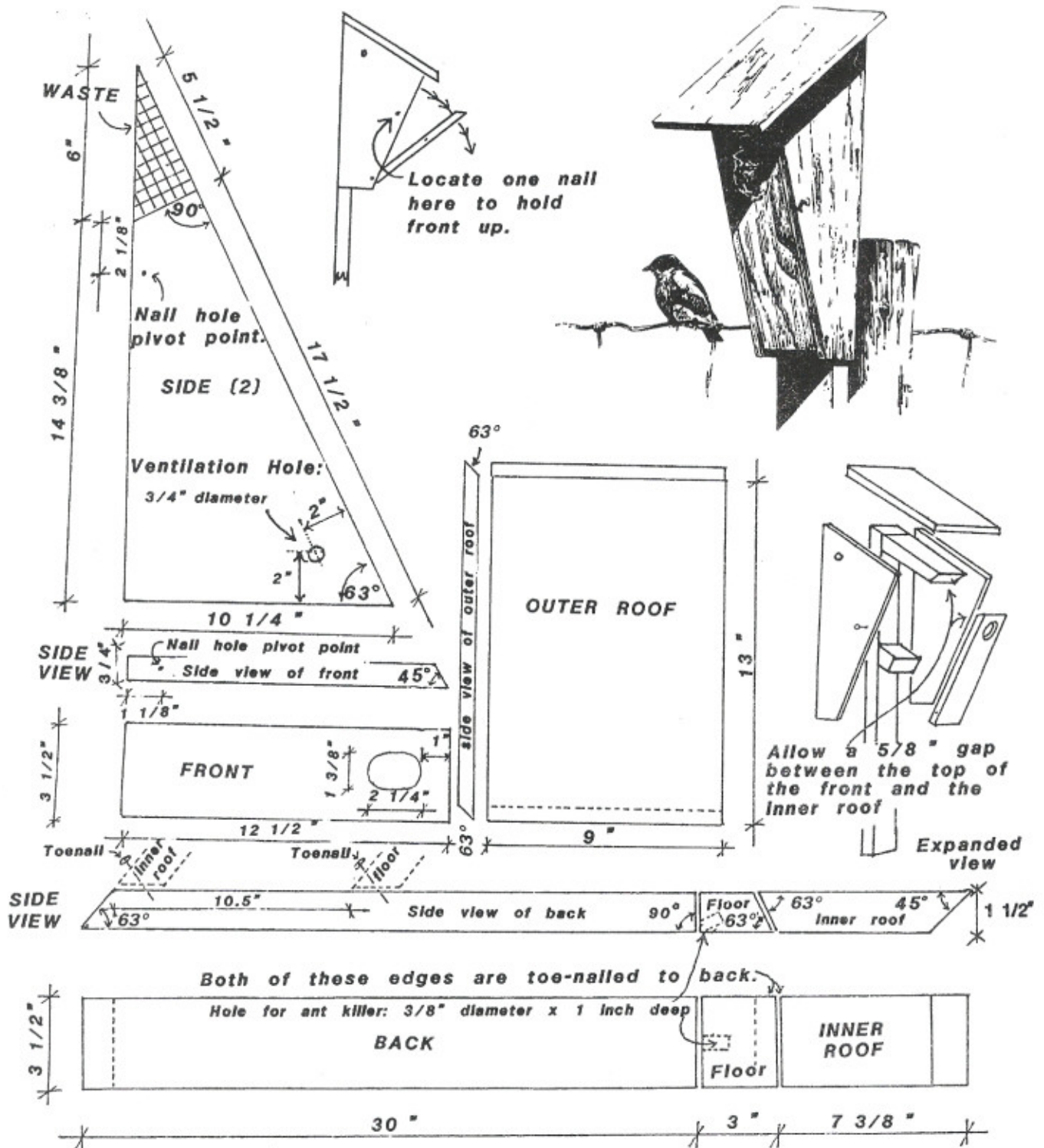
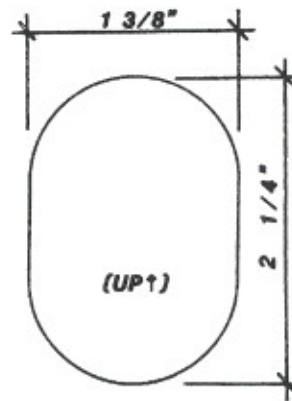
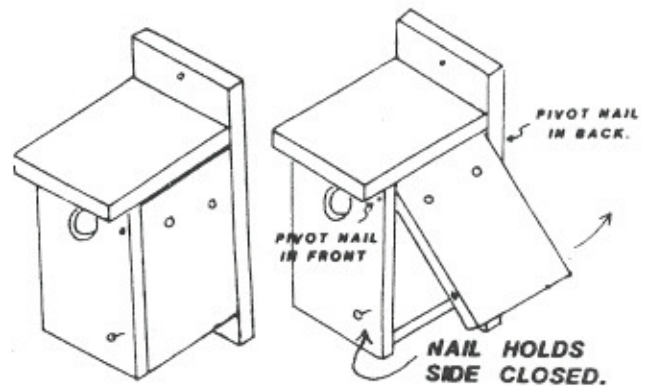
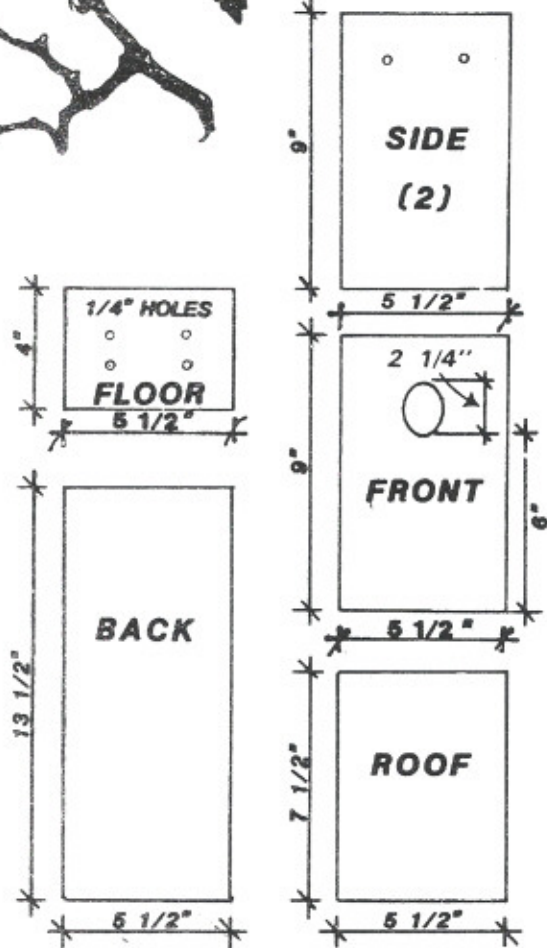


FIGURE 4

EASTERN BLUEBIRD  
GREAT CRESTED FLYCATCHER

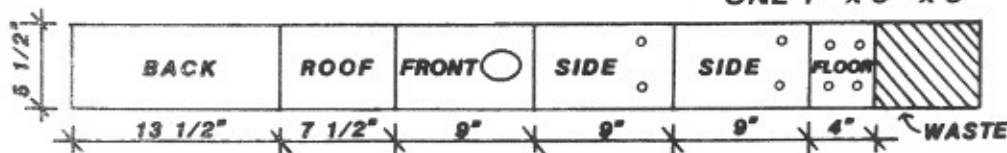


NOTE:  
Entrance hole for Great Crested Flycatcher should be a round hole 1 3/4" in diameter.  
If for bluebirds, a round hole should be 1 1/2" in diameter.



TWO "PIVOT" NAILS ALLOW SIDE TO SWING OUT FOR CLEANING.  
USE ONE NAIL AT BOTTOM TO CLOSE SIDE.

LUMBER:  
ONE 1" x 6" x 6'

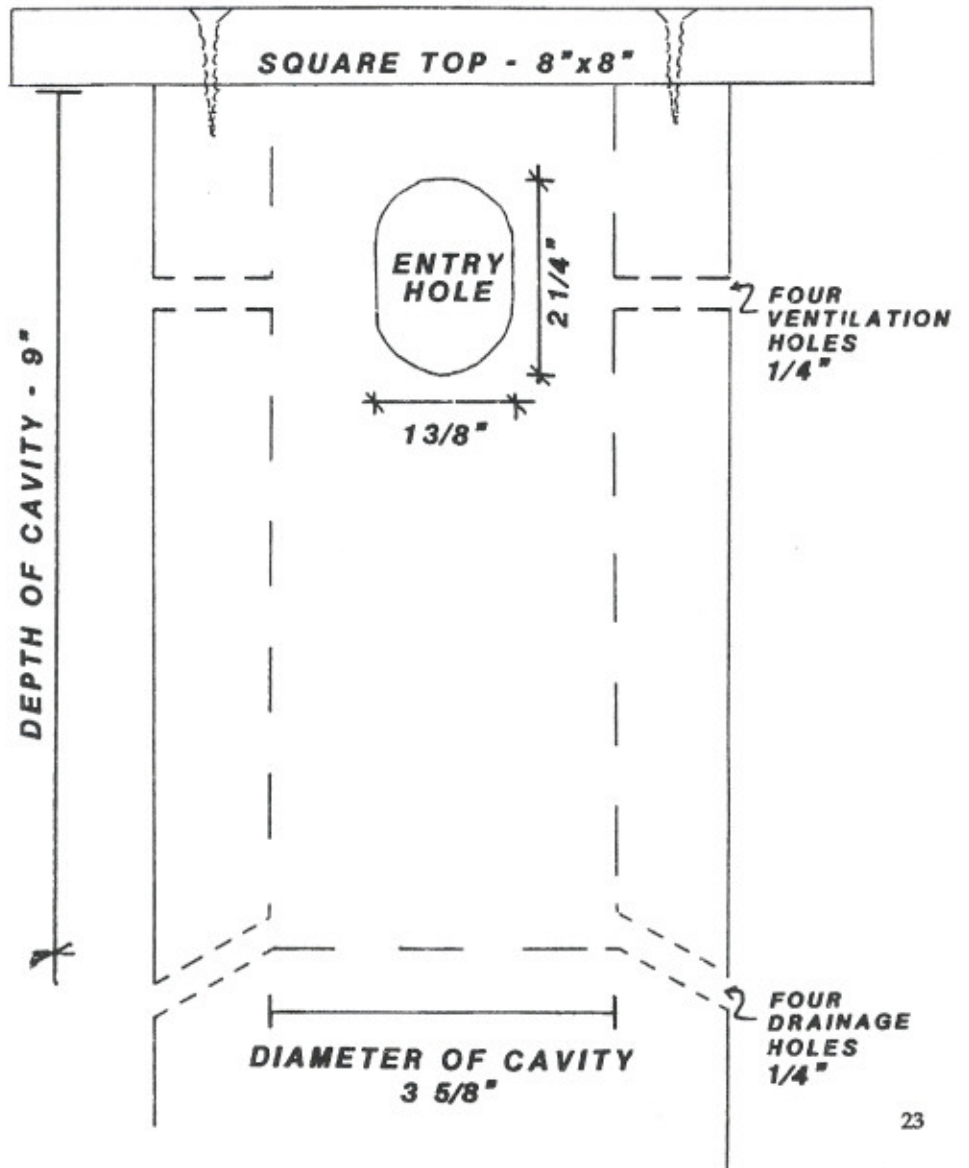


**FIGURE 5**

**EASTERN BLUEBIRD NESTING POST**

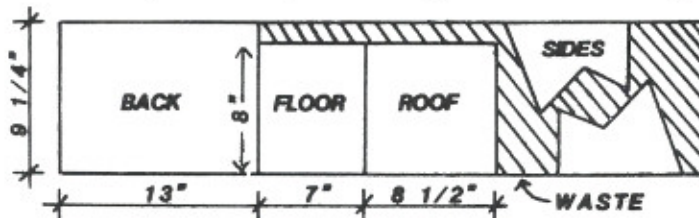
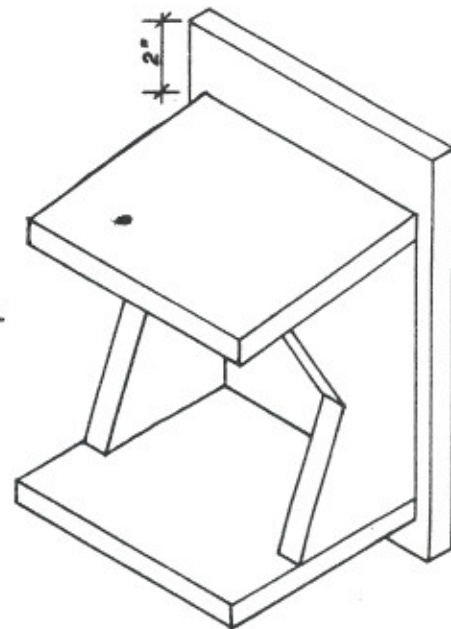
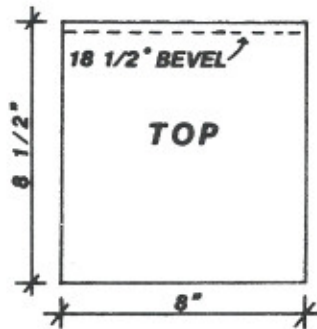
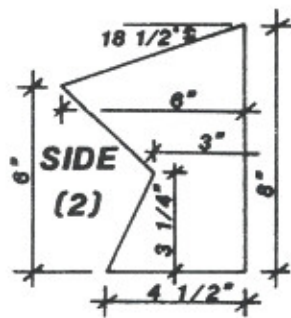
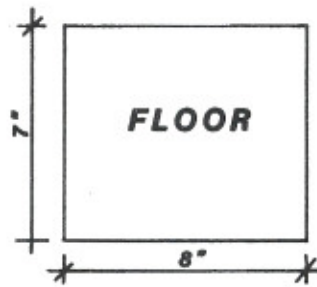


1. Use a 6" diameter post; no big knots.
2. Drill entry hole (two 1 3/8" holes).
3. Bore main post cavity (3 5/8" diameter, 9" deep)
4. Bore four 1/4" drainage holes and four 1/4" ventilation holes.
5. Screw top onto post.



**FIGURE 6**

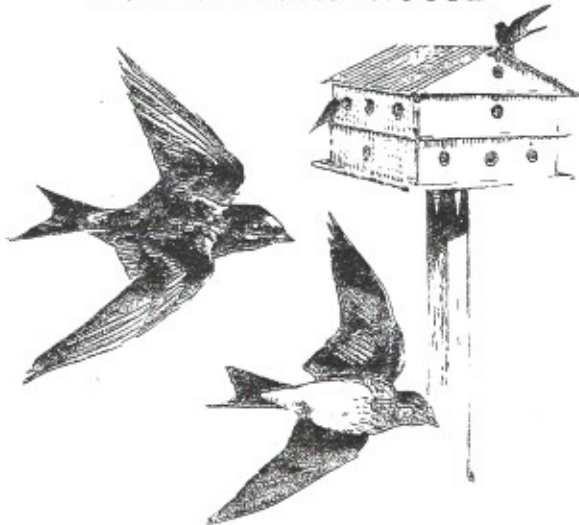
AMERICAN ROBIN  
 BARN SWALLOW  
 EASTERN PHOEBE  
 NEST SHELF



**LUMBER:**  
 ONE 1" x 10" x 6'0"

FIGURE 7

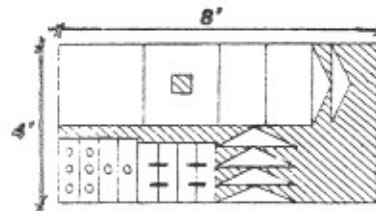
PURPLE MARTIN HOUSE



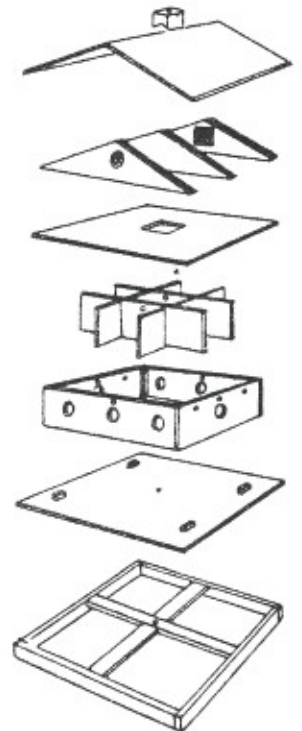
(not shown)  
Place 1/2" dowel railing around balcony to keep young from falling

MATERIALS:

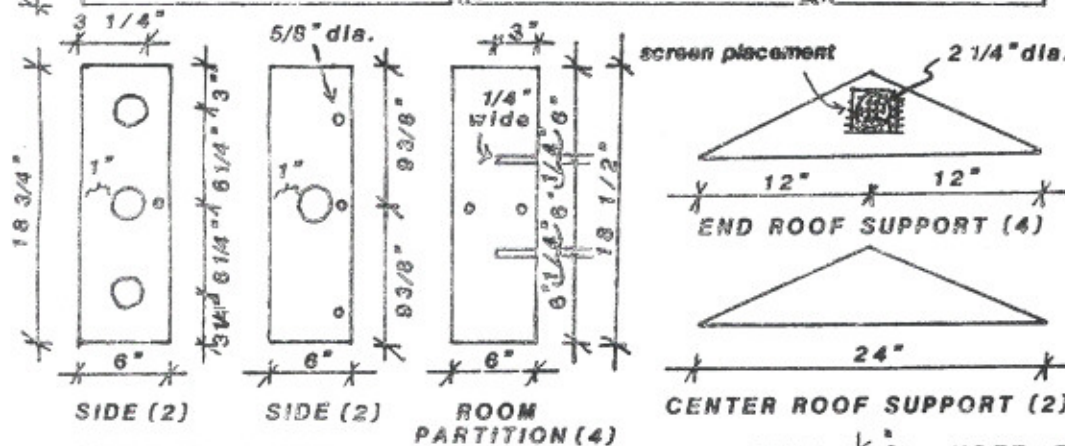
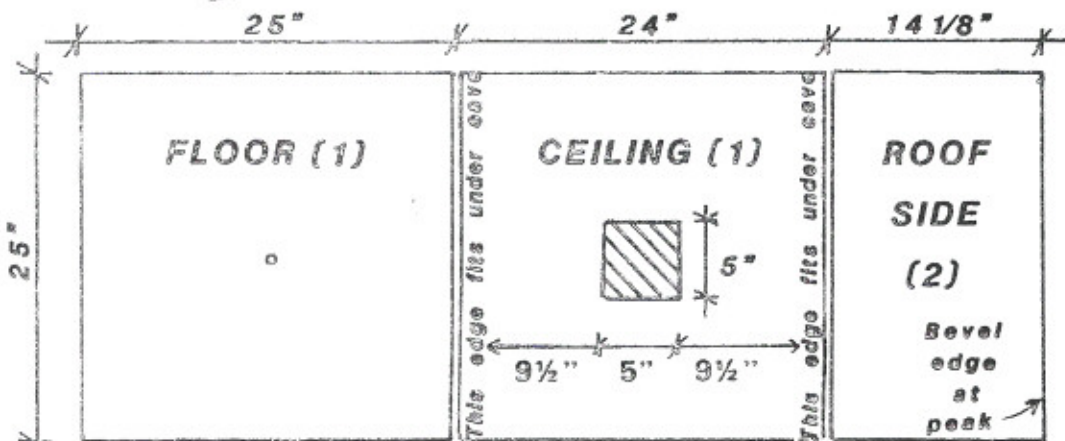
- 4'x8'x1/4" plywood
- 2"x2"x8" for chimney
- 1"x2"x14" (base)
- 1"x1"x8" (corner blocks)
- 4"x8" metal window screen
- 4" x 4" x 14' cedar post



Layout Pattern

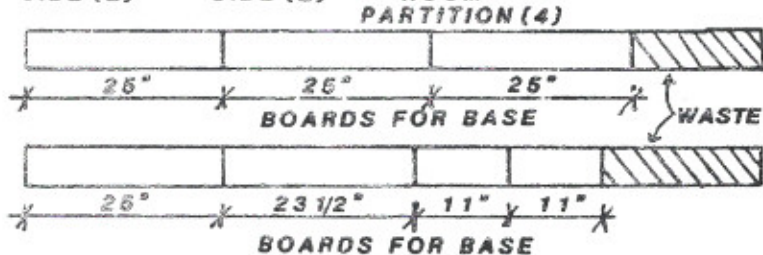


EXPANDED VIEW OF MARTIN HOUSE. A THREADED ROD INSERTS THROUGH THE BASE AND UP THROUGH THE CHIMNEY.



Entrance hole diameter :  
2 1/4"

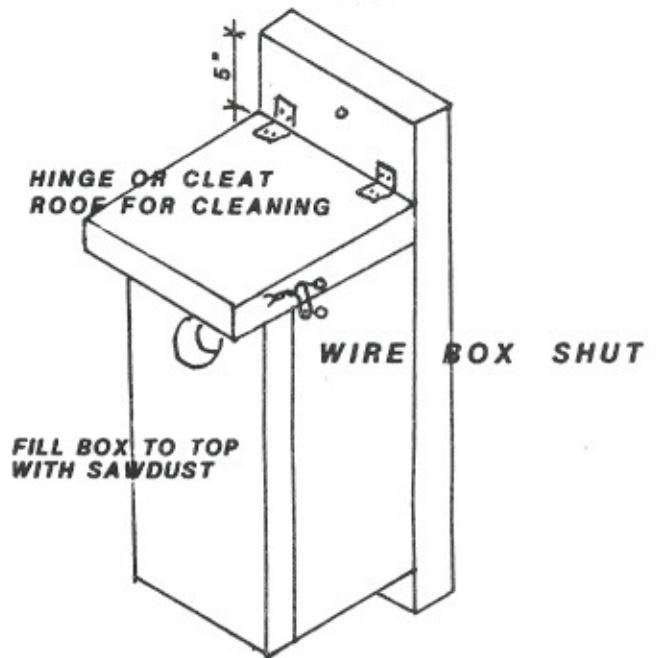
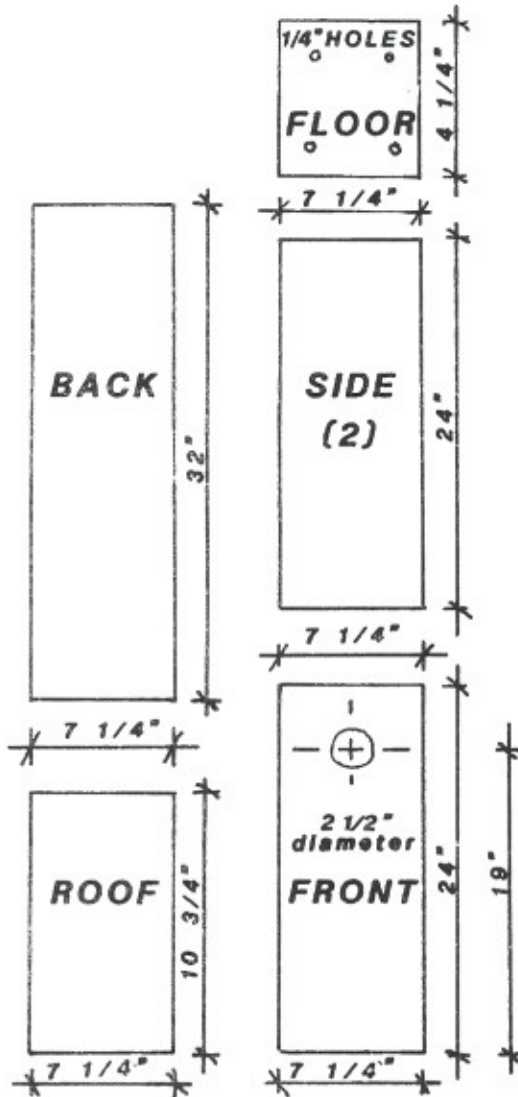
Locate 5/8" ventilation holes 1" below top edge of sides



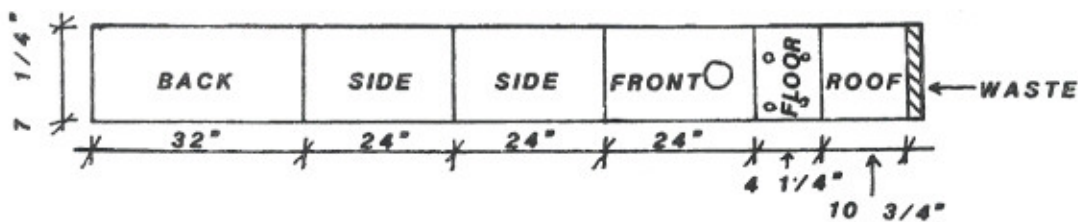
NOTE: This plan is for a one-story house. To add a second story, make one more ceiling unit (25"x25"), four more sides, and four more room partitions.

**FIGURE 8**

**NORTHERN FLICKER NEST BOX**

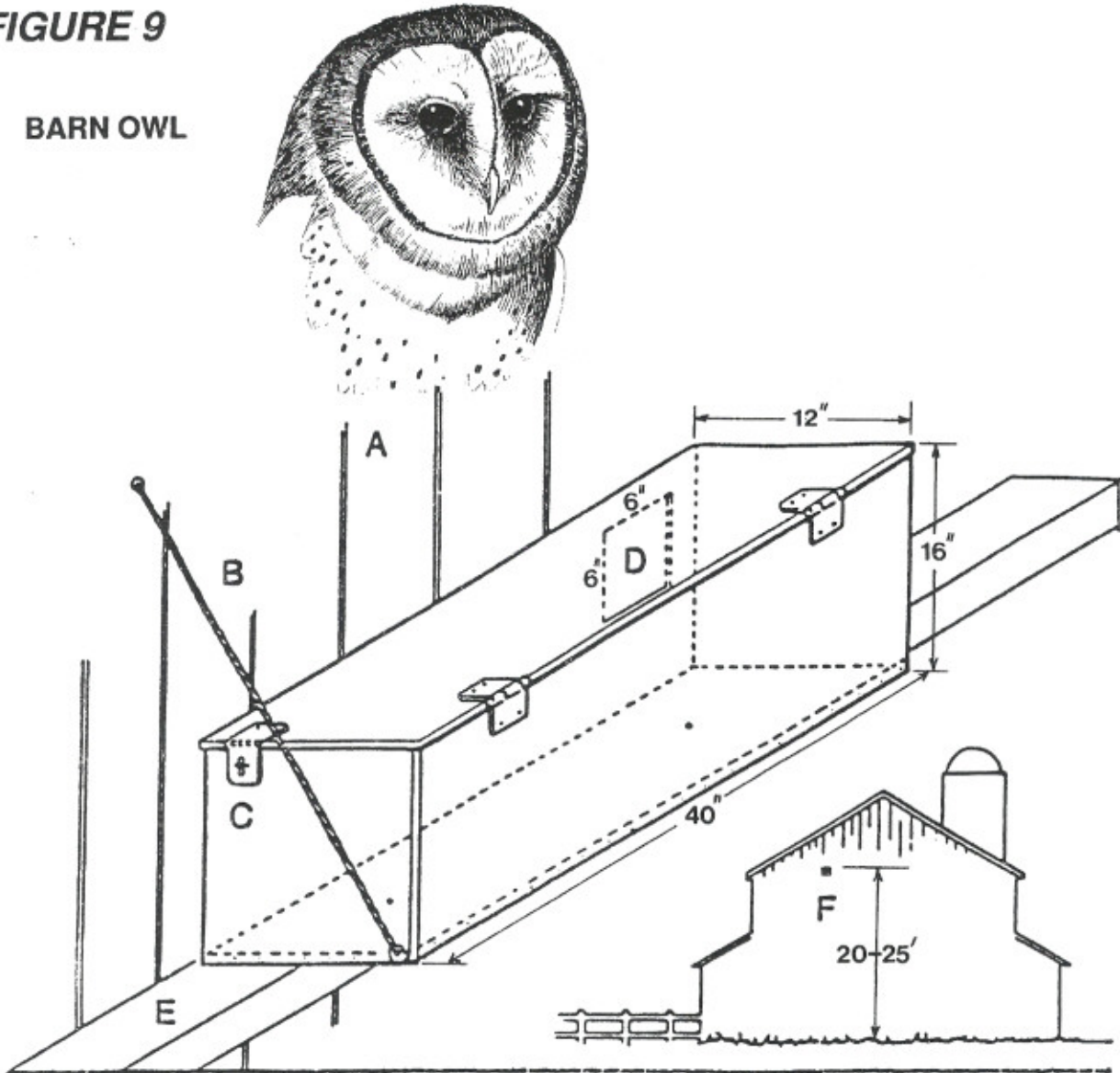


**LUMBER: ONE 2"x8"x12'0"**



**FIGURE 9**

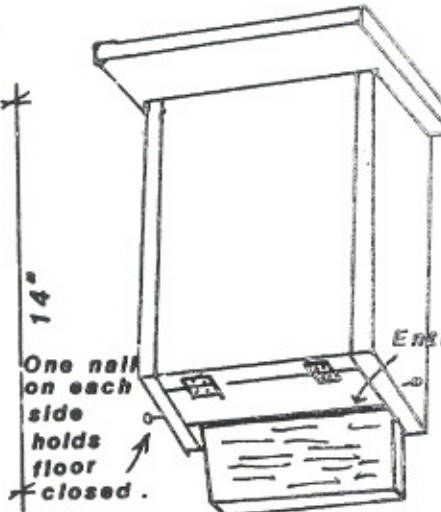
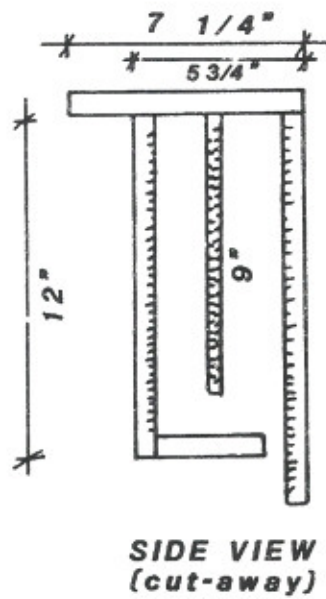
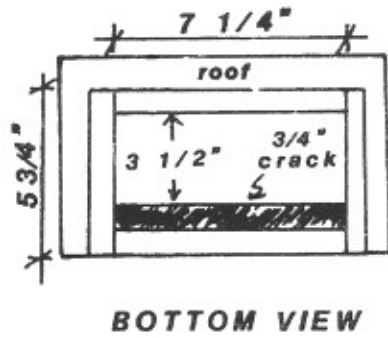
**BARN OWL**



- |  |   |
|--|---|
| <p>A. Interior of barn wall</p> <p>B. Wire (or wood) support<br/>if beam is narrow</p> <p>C. Latch</p> | <p>D. Entrance (6" above box floor)</p> <p>E. Crossbeam</p> <p>F. Entrance (6x6")</p> |
|--|---|

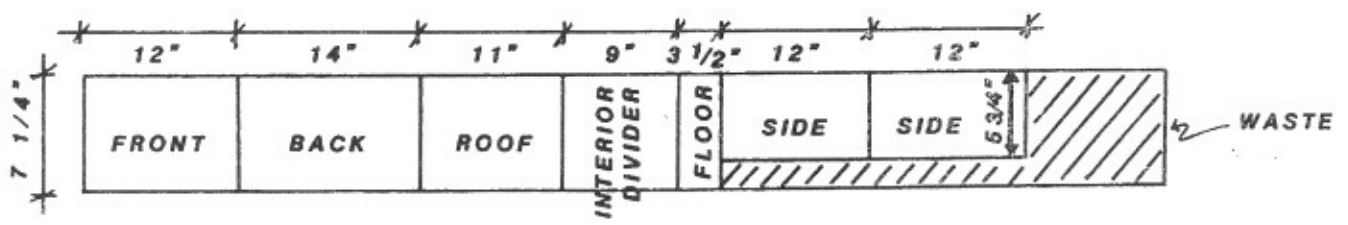
**FIGURE 10**

**BAT HOUSE**



Cover top and 2" down sides with tarpaper.

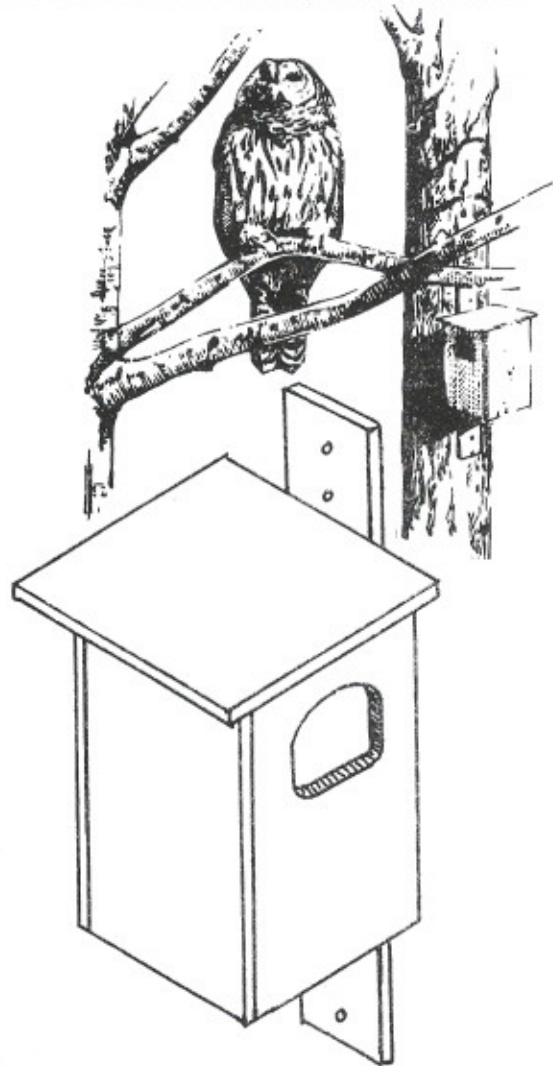
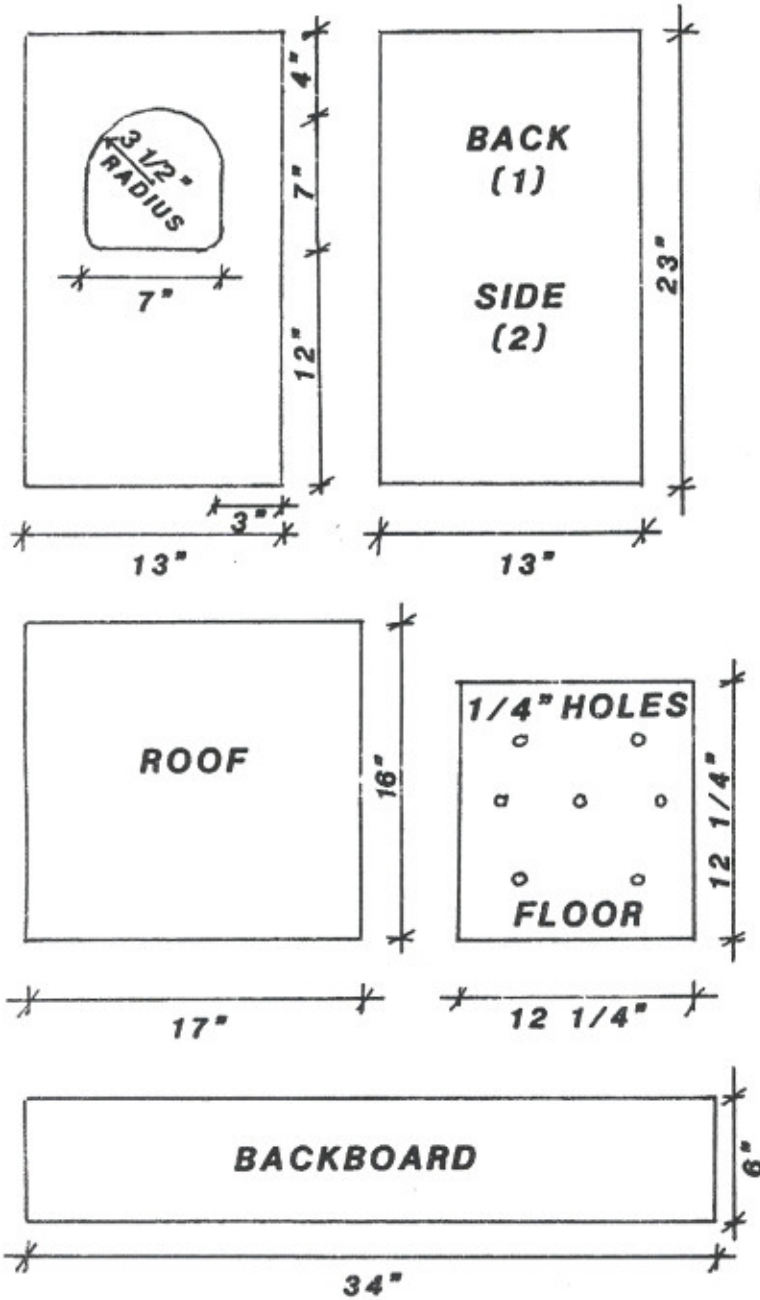
Score or scratch entryway and all inner surfaces to roughen.



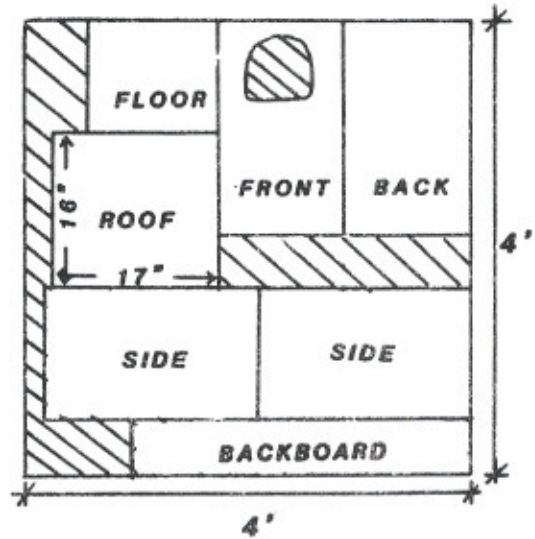
**LUMBER: One 1"x8"x 8'0"**

FIGURE 11

BARRED OWL NEST BOX



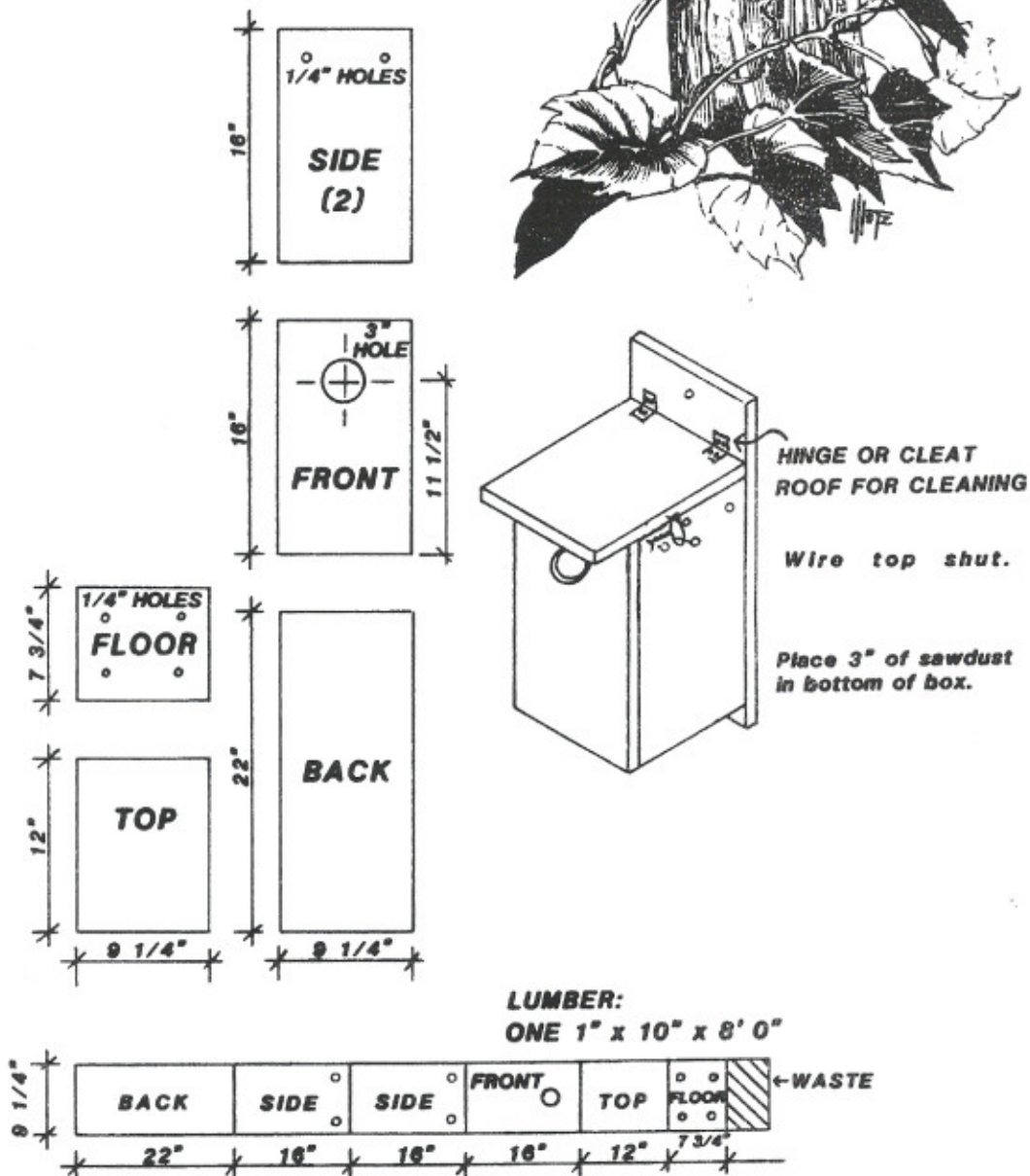
NOTE: No hinged door needed.  
Clean through entrance hole.



LUMBER: One 4'x4'x3/4" sheet exterior plywood,

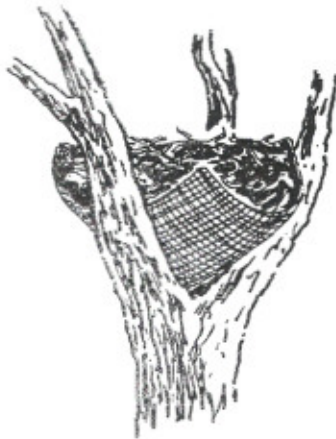
**FIGURE 12**

AMERICAN KESTREL  
 EASTERN SCREECH-OWL  
 NORTHERN & SOUTHERN FLYING SQUIRRELS  
 EASTERN RED SQUIRREL  
 NEST BOX

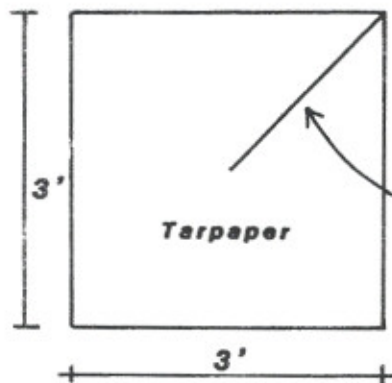
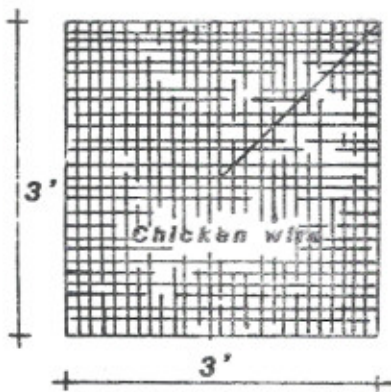


**FIGURE 13**

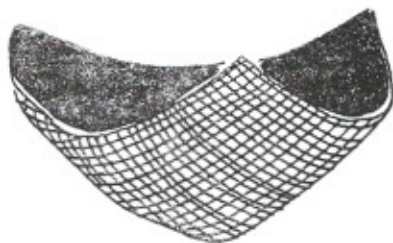
**GREAT HORNED OWL  
NEST PLATFORM**



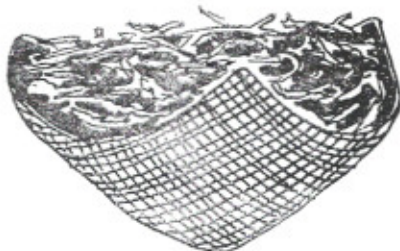
**MATERIALS:** One square yard 1" mesh chicken wire  
One square yard tarpaper



**CUT ALONG THESE LINES AND  
OVERLAP EDGES TO MAKE A CONE  
14" DEEP.**



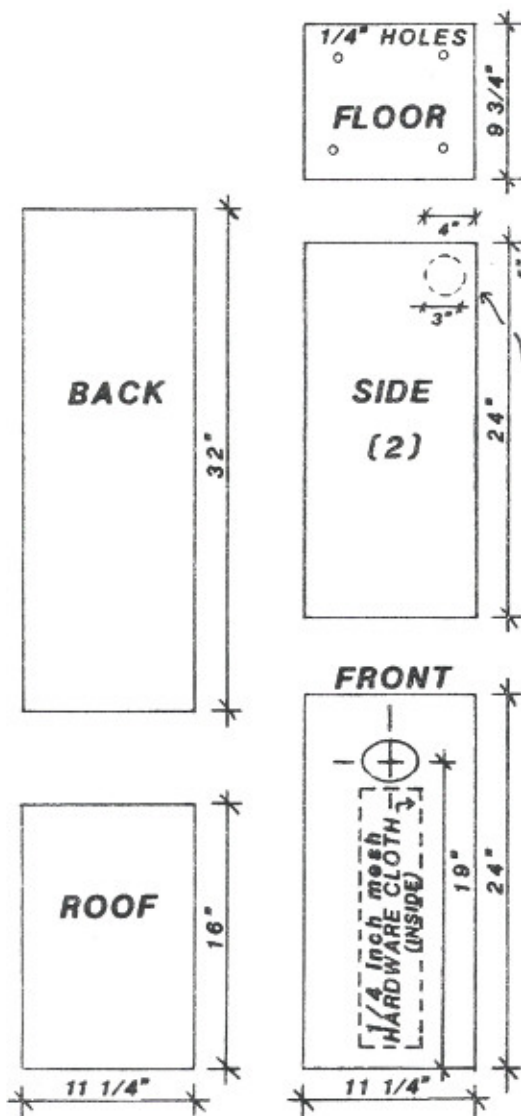
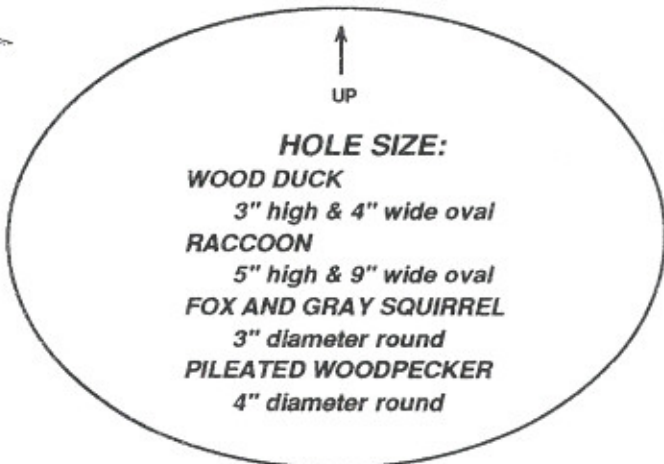
**LINE INSIDE OF WIRE CONE WITH TARPAPER.  
CUT DRAIN HOLE IN BOTTOM.**



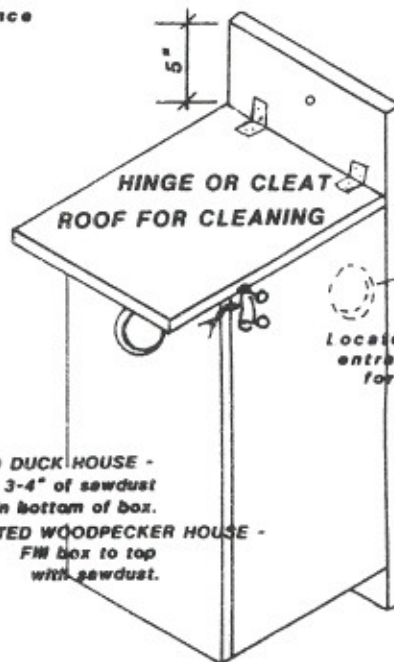
**CONSTRUCT STICK NEST INSIDE CONE, WIRING  
BRANCHES TO CONE THROUGH TARPAPER.  
RAISE FINISHED NEST INTO TREE WITH ROPE AND  
WIRE INTO A CROTCH OF THE TREE.**

**FIGURE 14**

WOOD DUCK  
 RACCOON  
 FOX & GRAY SQUIRREL  
 PILEATED WOODPECKER  
 NEST BOX



Optional site for squirrel box entrance

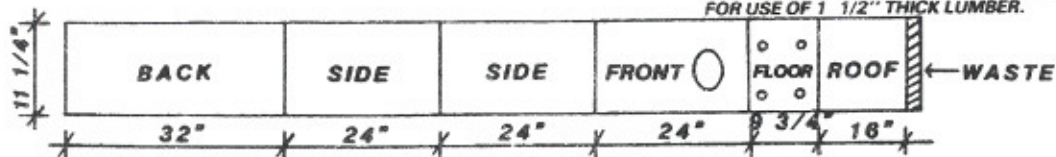


FOR WOOD DUCK HOUSE -  
 Place 3-4" of sawdust in bottom of box.  
 FOR PILEATED WOODPECKER HOUSE -  
 FW box to top with sawdust.

**LUMBER:**

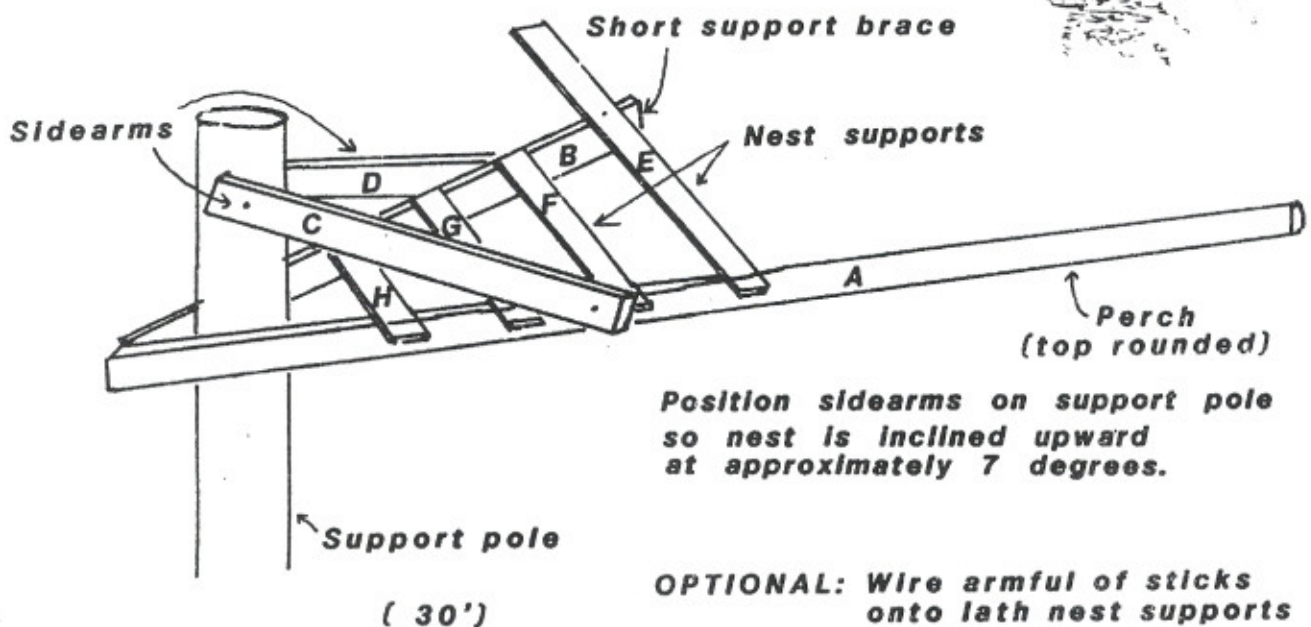
ONE 1" x 12" x 12' 0"

NOTE: PILEATED WOODPECKER BOX SHOULD BE CONSTRUCTED FROM ONE 2" x 12" x 12' 0" CEDAR, AND FLOOR MUST BE 8 1/4" LONG INSTEAD OF 9 3/4" FOR USE OF 1 1/2" THICK LUMBER.



**FIGURE 15**

**GREAT BLUE HERON  
DOUBLE-CRESTED CORMORANT  
NEST PLATFORM**



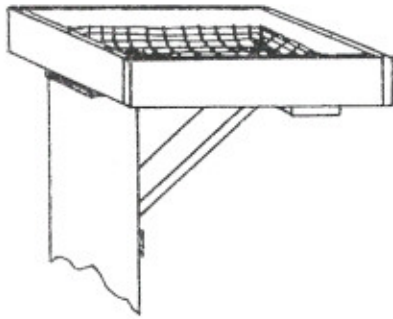
*Position sidearms on support pole so nest is inclined upward at approximately 7 degrees.*

**OPTIONAL:** *Wire armful of sticks onto lath nest supports to stimulate use.*

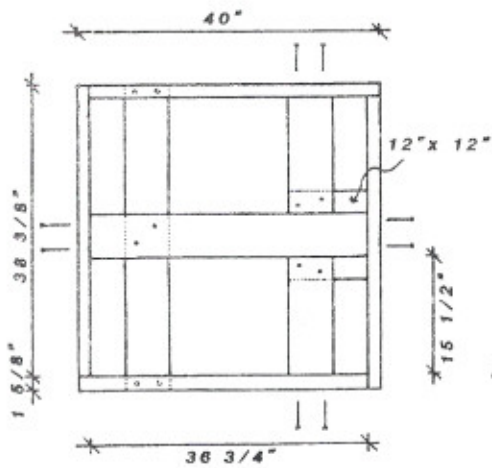
- LUMBER:**
- A - 2" x 2" x 7'
  - B - 2" x 2" x 30"
  - C and D - 1" x 2" x 26 1/2"
  - E - 1" x 2" x 39"
  - F - 1" x 2" x 19 1/2"
  - G - 1" x 2" x 19 1/4"
  - H - 1" x 2" x 17 7/8"
- One 30' cedar support pole / 3 platforms

FIGURE 16

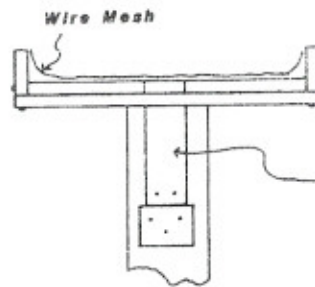
OSPREY NEST PLATFORM



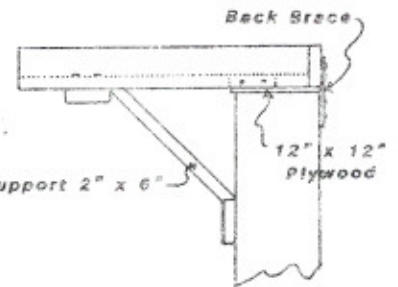
TOP VIEW



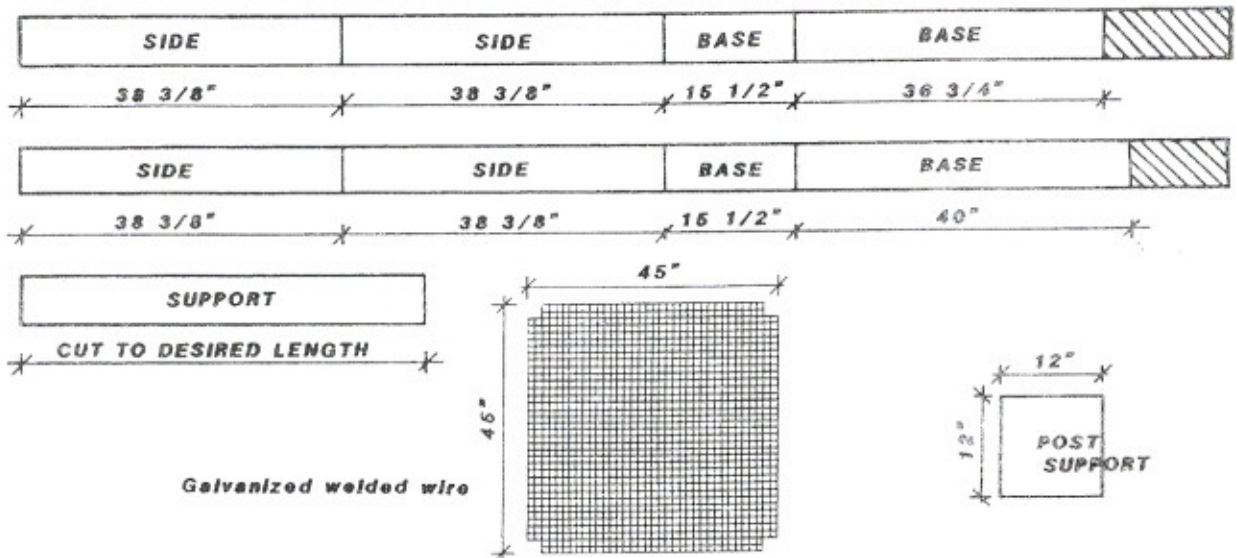
FRONT VIEW



SIDE VIEW

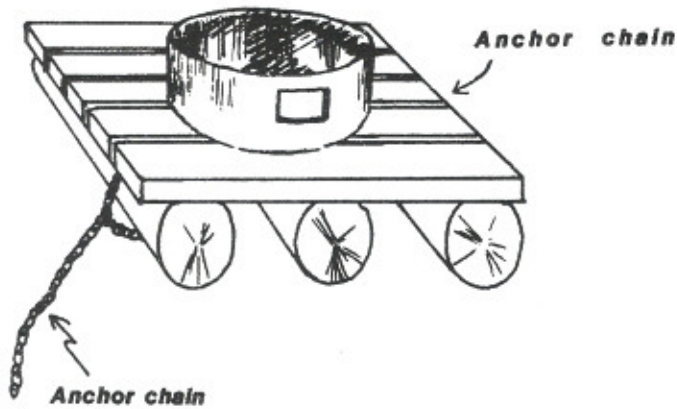


**LUMBER:** Two 2" x 6" x 12' cedar board  
 One 2" x 6" x 4' cedar board  
 One 12" x 12" x 1/2" exterior plywood  
 One 20' or 30' cedar support post

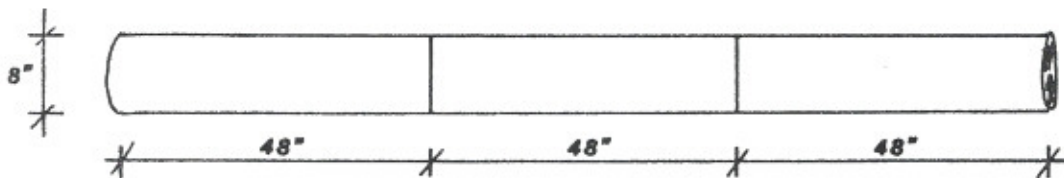
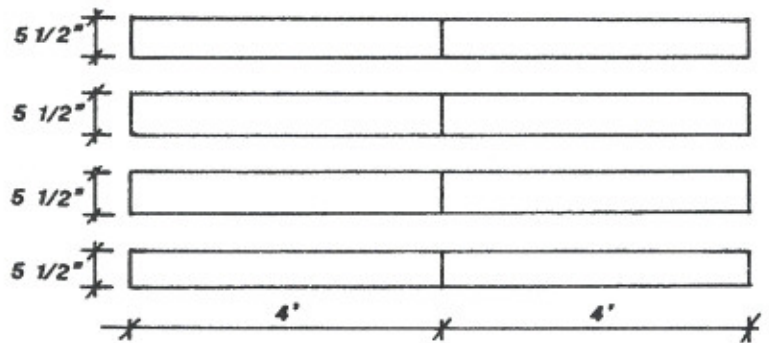
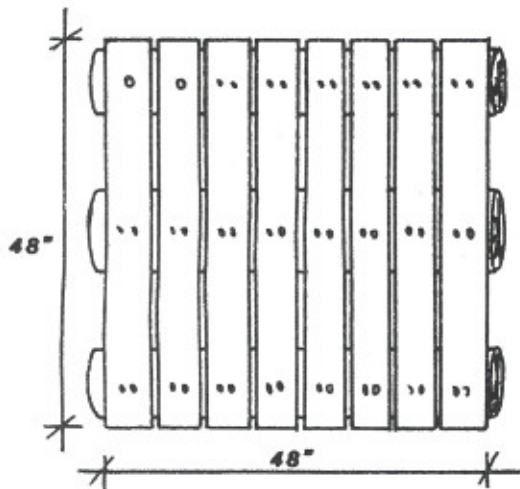


**FIGURE 17**

**CANADA GOOSE NEST PLATFORM  
TURTLE & DUCK LOAFING PLATFORM**



**MATERIALS: One 8" diameter cedar pole - 12' long**  
**Four 2"x6"x8' boards**  
**One 22" diameter round metal washtub**

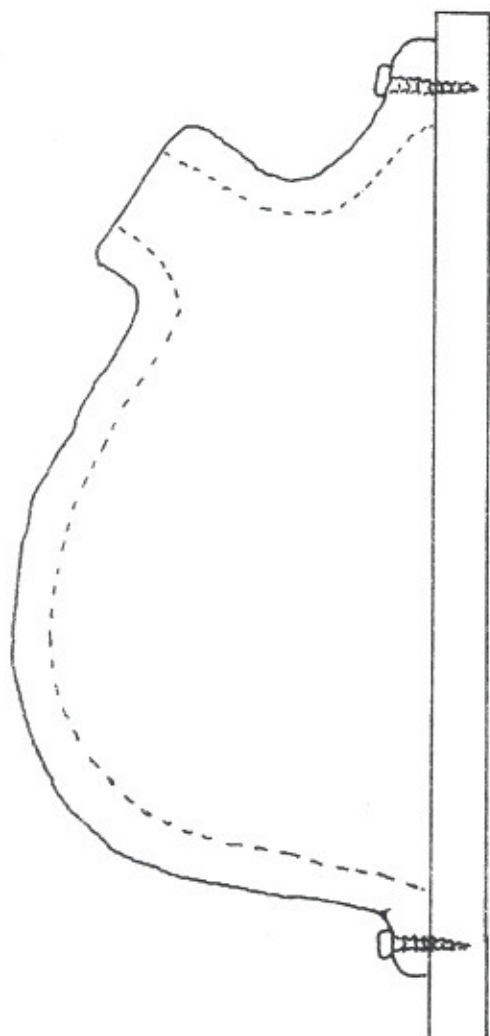


**FIGURE 18**

**CLIFF SWALLOW NEST**



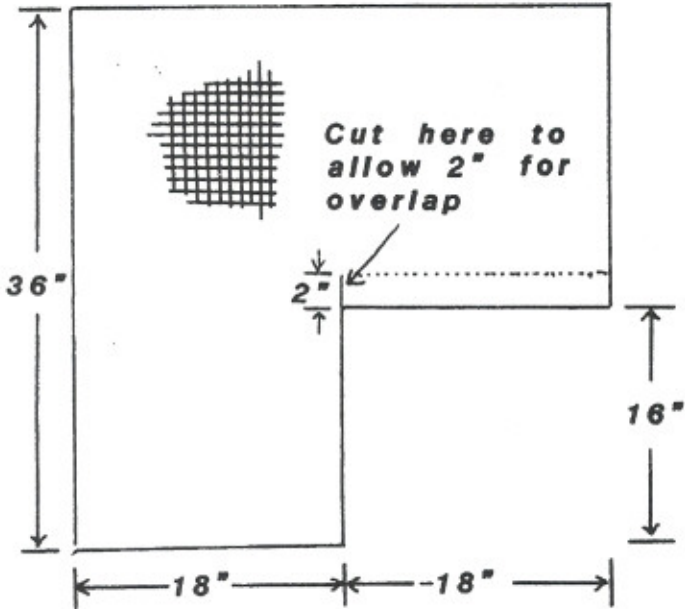
**Nest Sketch**



**Side view of nest  
cross-section  
attached to board**

FIGURE 19

MALLARD NEST BASKET

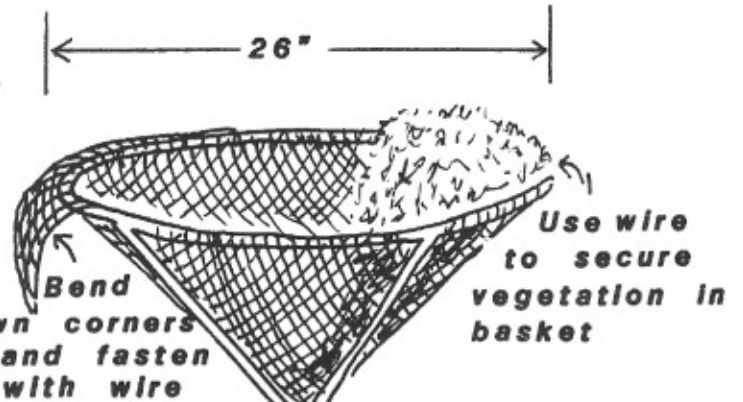


Cut here to allow 2" for overlap

36"  
18" 18"  
2"  
16"

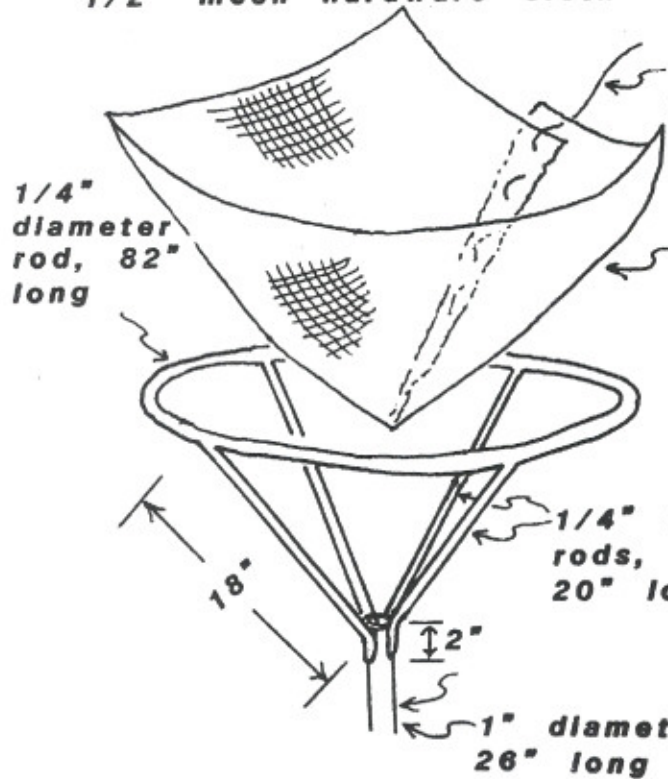
Basket Pattern  
1/2" mesh hardware cloth

Materials: 8' support pipe,  
1 1/2" diameter  
2' 2" basket pipe,  
1" diameter  
13' 6" steel rod,  
1/4" diameter  
3' X 3' hardware cloth,  
1/2" mesh



Bend down corners and fasten with wire

Use wire to secure vegetation in basket



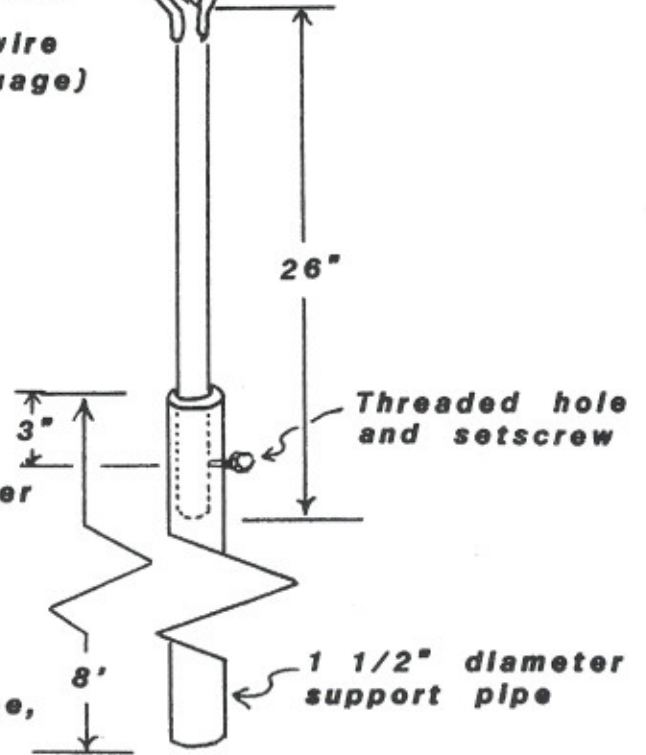
1/4" diameter rod, 82" long

Soft wire (14 gauge)

1/4" diameter rods, each 20" long

1" diameter pipe, 26" long

Nest Basket



26"

Threaded hole and setscrew

3"

8'

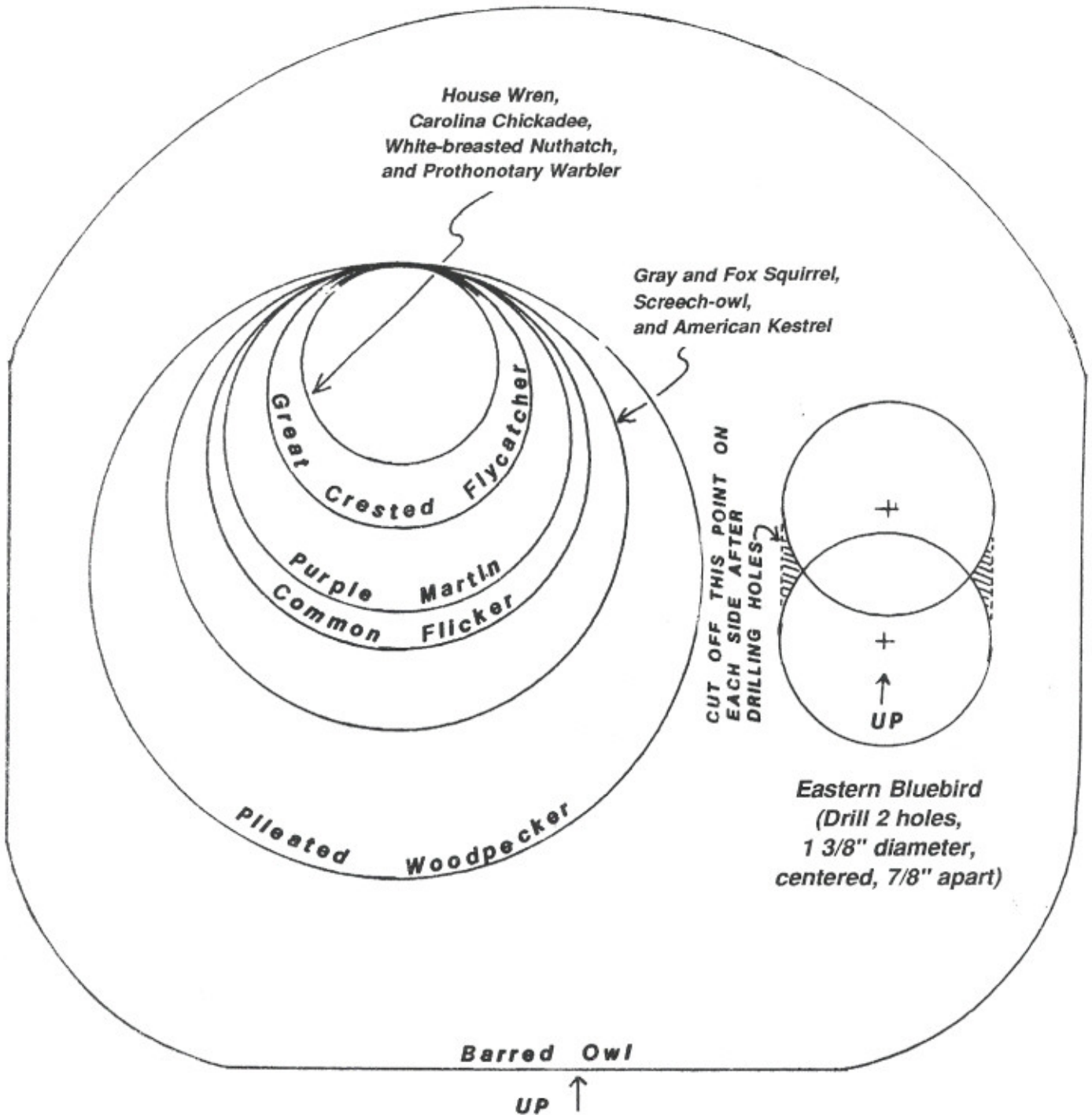
1 1/2" diameter support pipe

Frame and Basket Assembly

# FIGURE 20

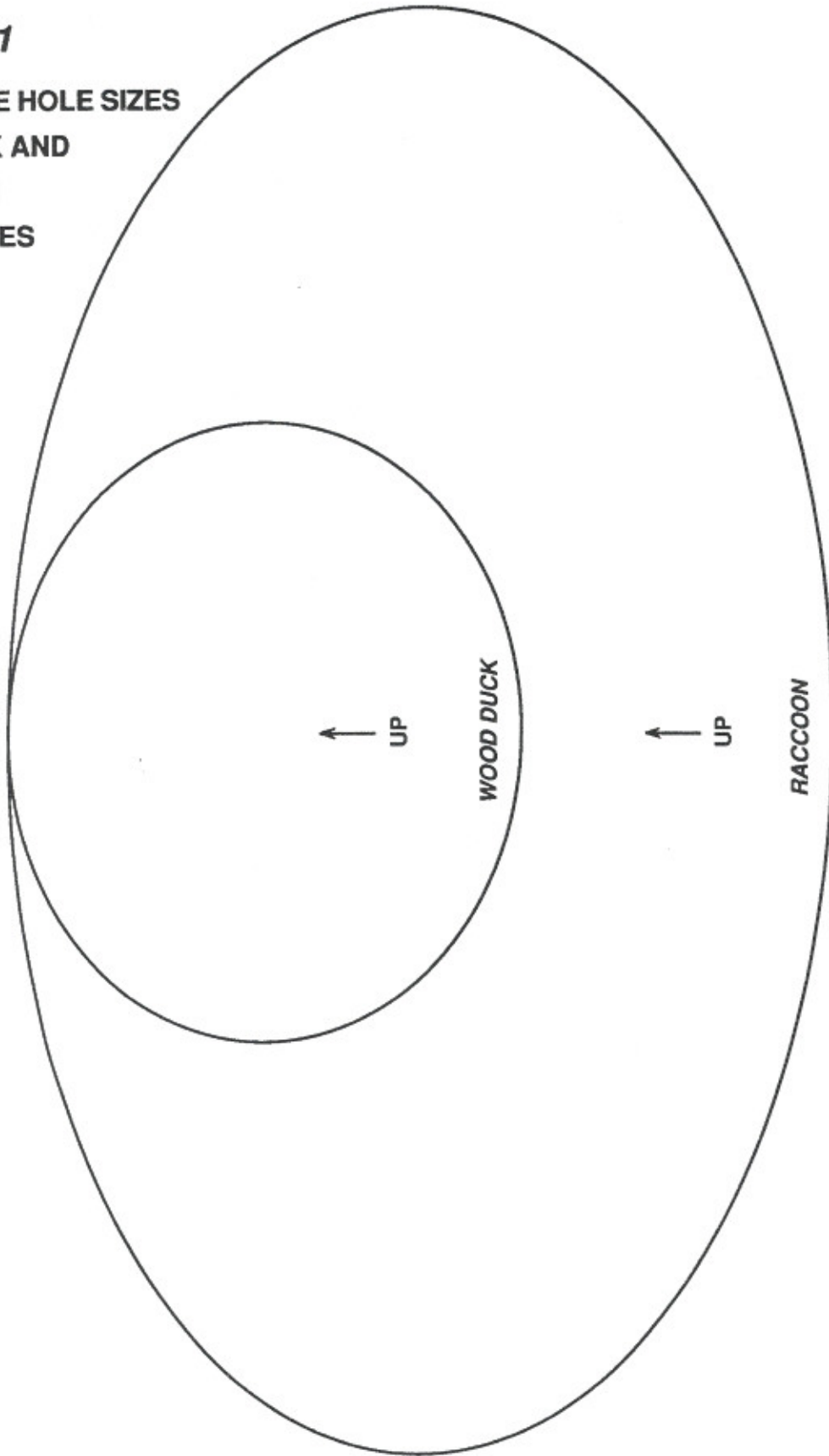
## ENTRANCE HOLE SIZES FOR SONGBIRD, WOODPECKER, AND SQUIRREL NEST BOXES

*Trace onto wood with carbon paper*



**FIGURE 21**

**ENTRANCE HOLE SIZES  
FOR DUCK AND  
RACCOON  
NEST BOXES**



*Trace onto wood with carbon paper.*